

### TVR 3735 FR/TOP

G.Cl 2872 FB

### TVR 3735/1 TOP

G.Cl 2672

### TVR 3735/2 TOP

G.Cl 2772

### TVR 3740 FR/TOP

G.Cl 3072 FB

### TVR 3740 FT/GB

G.Cl 3172 GB

### TVR 3740/1 TOP

G.Cl 4172

### TVR 3740/2 TOP

G.Cl 4972

### TVR 5540 FR/TOP

G.Cl 3572 FB

### TVR 5540 FT/GB

G.Cl 3672 GB

### TVR 5540/1 TOP

G.Cl 3372

### TVR 5540/2 TOP

G.Cl 3472

Zusätzlich erforderliche Unterlagen für den Komplettservice  
 Additionally required Service Documents for the Complete Service

#### Service Manual

TVR 3735...  
 TVR 3740...  
 TVR 5540...

Materialnr./Part No.  
 72010 536 6000

#### Service Manual

Sicherheit  
 Safety

Materialnr./Part No.  
 72010 800 0000

### Grundig Service

Hotline Deutschland...  
 ...Mo.-Fr. 8.00-18.00 Uhr

#### Technik:

TV	0180/52318-41
TV	0180/52318-49
SAT	0180/52318-48
VCR/LiveCam	0180/52318-42
HiFi/Audio	0180/52318-43
Car Audio	0180/52318-44
Telekommunikation	0180/52318-45
Fax:	0180/52318-51
Planatron (8.00-22.00 Uhr)	0180/52318-99

#### Ersatzteil-Verkauf:

Mo.-Fr. 8.00-19.00 Uhr

Telefon: 0180/52318-40  
 Fax: 0180/52318-50

Materialnummer/Part Number 72010 536 6100

Änderungen vorbehalten/Subject to alteration • Printed in Germany FD

E-BS34 0500 • 8002/8012, 8003/8013, 8005/8015

<http://www.grundig.com>

Es gelten die Vorschriften und Sicherheitshinweise gemäß dem Service Manual "Sicherheit", Materialnummer 72010 800 0000, sowie zusätzlich die eventuell abweichenden, landesspezifischen Vorschriften!



The regulations and safety instructions shall be valid as provided by the "Safety" Service Manual, part number 72010 800 0000, as well as the respective national deviations.

## D Inhaltsverzeichnis

Seite

### Allgemeiner Teil ..... 3-6

Geräteübersicht .....	3
Messgeräte / Messmittel .....	Service Manual 1-4
Technische Daten .....	Service Manual 1-4
Norm/Kanal-Tabellen .....	Service Manual 1-5
Bedienhinweise .....	Service Manual 1-7
Servicehinweise .....	4
Sonderfunktionen .....	6

### Beschreibung ..... 2-1...2-5

Leistungschassis (PS) .....	Service Manual 2-1
• Netzteil .....	Service Manual 2-1
• Hochspannungsteil .....	Service Manual 2-1
Signalchassis .....	Service Manual 2-2
• TV-Steuerung (CO) .....	Service Manual 2-2
• Laufwerksteuerung (DE) .....	Service Manual 2-2
• TV-Signalelektronik (TV) .....	Service Manual 2-3
• Empfangseinheit 2 (TU2) .....	Service Manual 2-4
• VCR-Signalelektronik (VS) .....	Service Manual 2-4

### Abgleichvorschriften ..... Service Manual 3-1...3-2

### Platinenabbildungen und Schaltpläne ..... 7...33

Verdrahtungsplan .....	7
Leistungschassis (PS)/Bildrohrplatte (CRT) .....	9
Signalchassis .....	13
• TV-Steuerung (CO) .....	17
• Kopfverstärker (HA) .....	18
• Laufwerksteuerung (DE) .....	19
• TV-Signalelektronik (TV) .....	21
• Empfangseinheit 2 / SECAM-L-Demodulator (TU2) .....	23
• VCR-Signalelektronik (VS) .....	25
Bedienplatte (TM) .....	27
Oszillogramme .....	28
Blockschaltplan – Netzteil/Digital .....	32
Blockschaltplan – TV/VCR .....	33

### Laufwerk ..... 5-1...5-5

Messgeräte / Messmittel .....	Service Manual 5-1
Laufwerkübersicht .....	Service Manual 5-1
Ausbauhinweise .....	Service Manual 5-2
Einstellungen .....	Service Manual 5-4

### Explosionszeichnung und Ersatzteillisten ..... 34...44

## GB Table of Contents

Page

### General Section ..... 3-6

TVR Overview .....	3
Test Equipment / Jigs .....	Service Manual 1-4
Specifications .....	Service Manual 1-4
Tables of Norms .....	Service Manual 1-5
Operating Hints .....	Service Manual 1-14
Service Instructions .....	5
Special Functions .....	6

### Discription ..... 2-6...2-10

Power Chassis (PS) .....	Service Manual 2-6
• Power Supply .....	Service Manual 2-6
• High Voltage Section .....	Service Manual 2-6
Signal Chassis .....	Service Manual 2-7
• TV Control (CO) .....	Service Manual 2-7
• Deck Control (DE) .....	Service Manual 2-7
• TV Signal Electronics (TV) .....	Service Manual 2-8
• Frontend 2 (TU2) .....	Service Manual 2-9
• VCR Signal Electronics (VS) .....	Service Manual 2-9

### Adjustment Procedures .... Service Manual 3-3...3-4

### Layout of the PCBs and Circuit Diagrams ..... 7...33

Wiring Diagram .....	7
Power Chassis (PS)/Picture Tube PCB (CRT) .....	9
Signal Chassis .....	13
• TV Control (CO) .....	17
• Head Amplifier (HA) .....	18
• Drive Control (DE) .....	19
• TV Signal Electronic (TV) .....	21
• Frontend 2 / SECAM L Demodulator (TU2) .....	23
• VCR Signal Electronic (VS) .....	25
Keyboard Control Unit (TM) .....	27
Oscillograms .....	28
Block Circuit Diagram – Power Supply/Digital .....	32
Block Circuit Diagram – TV/VCR .....	33

### Drive Mechanism ..... 5-6...5-10

Test Equipment / Jigs .....	Service Manual 5-6
Overview of the Drive Mechanism .....	Service Manual 5-6
Disassembly Instructions .....	Service Manual 5-7
Adjustments .....	Service Manual 5-9

### Exploded View and Spare Parts Lists ..... 34...44

# Allgemeiner Teil / General Section

## Geräteübersicht / TVR Overview

		Ergänzung 1 Supplement 1 Materialnr./Part No. 72010 536 6100	TVR 3735/1 TOP	TVR 3735/2 TOP	TVR 3735 FR/TOP	TVR 3740/1 TOP	TVR 3740/2 TOP	TVR 3740 FR/TOP	TVR 3740 FT/GB	TVR 5540/1 TOP	TVR 5540/2 TOP	TVR 5540 FR/TOP	TVR 5540 FT/GB	
<b>Bausteinübersicht</b> Table of Modules	S./P 9	Leistungschassis / Power Chassis (PS)	•	•	•	•	•	•	•	•	•	•	•	
	S./P 9	Bildrohrplatte / Tube PCB (CRT)	•	•	•	•	•	•	•	•	•	•	•	
	S./P 13 S./P 17 S./P 18 S./P 19 S./P 21 S./P 23 S./P 25	Signalchassis / Signal Chassis · TV-Steuerung / TV Control (CO) · Kopfverstärker / Head Amplifier (HA) · Laufwerksteuerung / Drive Control (DE) · TV-Signalelektronik / TV Signal Electronic (TV) · Empfangseinheit 2 / Frontend 2 / SECAM L Demodulator (TU2) · VCR-Signalelektronik / VCR Signal Electronic (VS)	•	•	•	•	•	•	•	•	•	•	•	•
	S./P 27	Bedienplatte / Keyboard Control Unit (TM)	•	•	•	•	•	•	•	•	•	•	•	
<b>Feature-Übersicht</b> Table of Features	CCIR, B/G/H - PAL		•	•	•	•	•	•		•	•	•		
	CCIR, D/K - PAL													
	CCIR, I - PAL								•				•	
	CCIR, B/G - SECAM			•			•					•		
	CCIR, D/K - SECAM													
	CCIR, L/L' - SECAM			•			•					•		
	NICAM													
	2 Empfangseinheiten / Frontend (Tuner)					•	•	•	•	•	•	•	•	
	Bildschirmdiagonale 37cm (sichtbares Bild: 34cm) / Screen diagonale 37cm (visible picture: 34cm)		•	•	•	•	•	•	•					
	Bildschirmdiagonale 55cm (sichtbares Bild: 51cm) / Screen diagonale 55cm (visible picture: 51cm)									•	•	•	•	
	NTSC-Wiedergabe / NTSC Playback		•	•	•	•	•	•	•	•	•	•	•	
	S-VHS-Aufnahme / S-VHS Record													
	S-VHS-Wiedergabe / S-VHS Playback													
	2 Kopf / Head (Video)		•	•	•	•	•	•	•					
	4 Kopf / Head (Video)									•	•	•	•	
	2 Kopf / Head (Audio)													
	HiFi-Stereo													
	Normalplay		•	•	•	•	•	•	•	•	•	•	•	
	Longplay		•	•	•	•	•	•	•	•	•	•	•	
	Energiesparend / Low Power (Standby ≤4W)		•	•	•	•	•	•	•	•	•	•	•	
	VPS		•	•	•	•	•	•	•	•	•	•	•	
	PDC		•	•	•	•	•	•	•	•	•	•	•	
	6 Timer		•	•	•	•	•	•	•	•	•	•	•	
	SHOW VIEW		•	•	•	•	•	•	•		•	•		
	Video Plus									•			•	
	69 Programme		•	•	•	•	•	•	•	•	•	•	•	
	Teletext "DOS"		•	•	•	•	•	•	•	•	•	•	•	
	OSD		•	•	•	•	•	•	•	•	•	•	•	
	Kindersicherung / Child Lock		•	•	•	•	•	•	•	•	•	•	•	
	Nachvertonung / Dubbing													
	Insert-Schnitt / Insert Edit													
	Video Index Such System (VISS)		•	•	•	•	•	•	•	•	•	•	•	
	EURO-AV-Buchse / Socket EURO-AV		•	•	•	•	•	•	•	•	•	•	•	
"PAY-TV"-Buchse / Socket (EURO-AV2)														
LINE-Eingangs-Buchsen / Input Sockets														
LINE-Ausgangs-Buchsen / Output Sockets														
Camcorder-Eingangs-Buchsen / Input Sockets		•	•	•	•	•	•	•	•	•	•	•		
"SYNCHRO-EDIT"-Buchse / Socket (ø 2,5mm Klinkenbuchse / mini-minijack)														
Mikrofonbuchse / Micro Jack														
Kopfhörerbuchse / Headphone Jack		•	•	•	•	•	•	•	•	•	•	•		
SAT-Steuerbuchse / SAT Remote Control														

## Servicehinweise

### 1. Ausbauhinweise

#### 1.1 Gehäuserückwand

- 4 Schrauben (A) herausdrehen (Fig. 1, Beispiel TVR3740).
- Gehäuserückwand abnehmen.

#### 1.2 Leistungschassis

- Schraube (B) und 2 Schrauben (C) herausdrehen (Fig. 2).
- Leistungschassis zur Geräterückseite schieben und nach oben abnehmen.
- Gegebenenfalls Steckverbindungen lösen.

#### Sicherheitshinweis

- Im Servicefall immer Trenntrafo benutzen.

#### 1.3 Einschub

- Steckverbindungen auf dem Leistungschassis (P405, P406, P805) und auf der Bildrohrplatte (P901) lösen und die Kabel freilegen (Fig. 2).
- Rastnase (D) an der Geräteunterseite lösen (Fig. 3).
- Einschub zur Geräterückseite schieben bis die 2 Schrauben (E) (links und rechts) zugänglich sind (Fig. 4).
- Steckverbindung (Fig. 7, PF03) auf der Bedieneinheit lösen.
- je 2 Schrauben (E), (F), (G) (links und rechts) herausdrehen (Fig. 4).
- Einschuboberteil (Abschirmblech und Leistungschassis) anheben und Einschub (Signalchassis und Laufwerk) nach hinten herausnehmen.

#### Servicestellung: siehe Fig. 5

- In dieser Servicestellung ist der Lautsprecher nicht anschließbar.

#### Montagehinweis

- Beim Einschieben des Einschubes von hinten in das Gerät ist die Cassettenklappe zu öffnen. Der Cassettenklappenöffner befindet sich dadurch vor der Cassettenklappe in richtiger Position.

#### 1.3.1 Laufwerk

- Schrauben (I), (J), (K), (L) (Fig. 6) herausdrehen.
- Abschirmblech (M) (Fig. 6) abnehmen.
- Steckverbindungen (Fig. 6, PAN01 / PAY01 / PAY02 / PAY03) lösen.
- Laufwerk vorsichtig abnehmen.

#### 1.3.2 Signalchassis

- Steckverbindungen (Fig. 7, PF01 / PF02) auf der Bedieneinheit lösen.
- Schrauben (N) (Fig. 6) herausdrehen.
- Rastnasen (O) (Fig. 6) lösen.
- Signalchassis aus dem Montagerahmen nehmen.

#### 1.3.3 Bedieneinheit

- Steckverbindungen (Fig. 7, PF01 / PF02 / PF03) lösen.
- Rastnasen (P) (Fig. 7) lösen.
- Bedieneinheit abnehmen.

### 2. Wichtige Netzkabel-Zugentlastung

Beim Zusammenbau des Gerätes muss das Netzkabel mit der Zugentlastung gemäß Fig. 8 im Geräteboden eingerastet und entsprechend Fig. 9 in der Rückwand verlegt sein.

### 3. Wichtige Masseverbindungen!

Beim Zusammenbau des Gerätes ist darauf zu achten, dass die Masseverbindungen zwischen den einzelnen Bausteinen gewährleistet sind (zum Beispiel Fig. 10/11).

### 4. Durchführen von Messungen

Bei Messungen mit dem Oszilloskop an Halbleitern sollten Sie nur Tastköpfe mit 10:1 - Teiler verwenden. Außerdem ist zu beachten, dass nach vorheriger Messung mit AC-Kopplung der Koppelkondensator des Oszilloskops aufgeladen sein kann. Durch die Entladung über das Messobjekt können diese Bauteile beschädigt werden.

### 5. Messwerte und Oszillogramme

Bei den in den Schaltplänen und Oszillogrammen angegebenen Messwerten handelt es sich um Näherungswerte!



Fig. 1

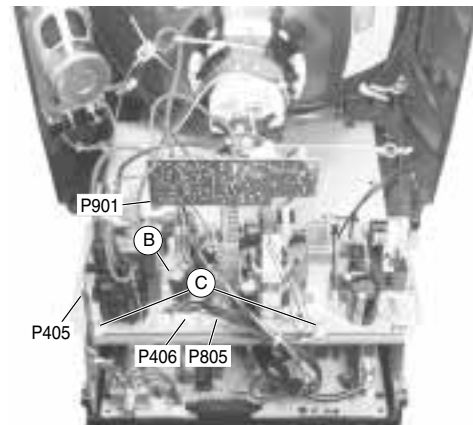

Fig. 2



Fig. 3

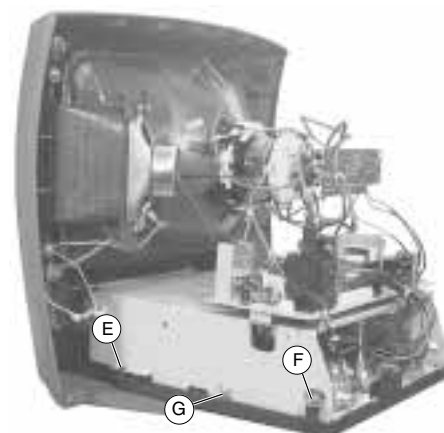

Fig. 4

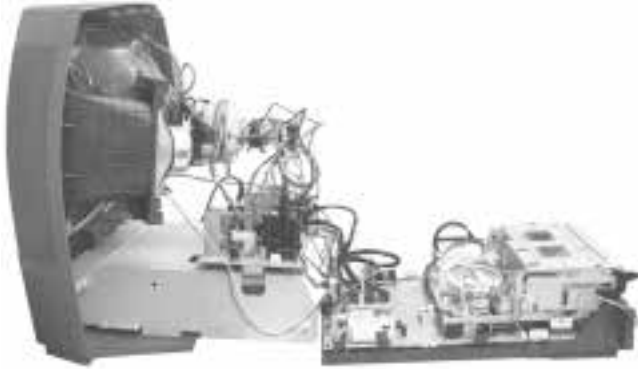

Fig. 5

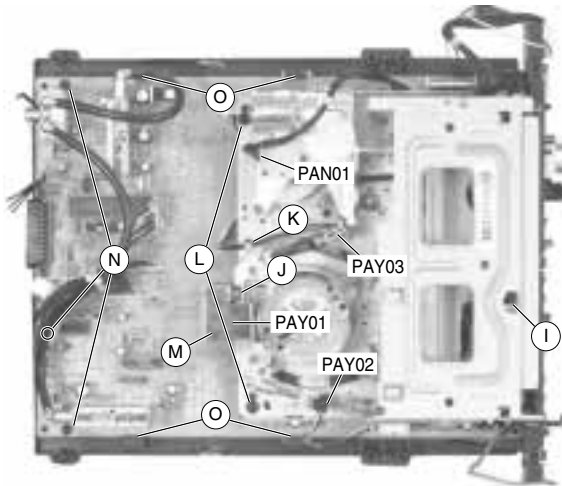

Fig. 6

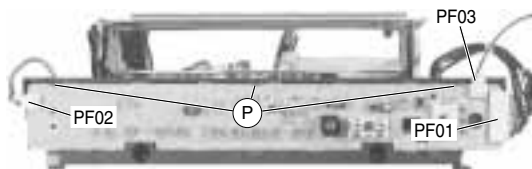

Fig. 7

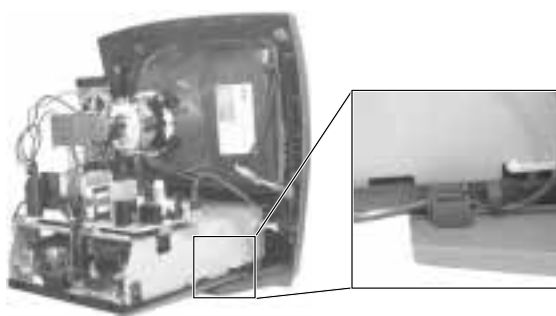

Fig. 8



Fig. 9

## Service Instructions

### 1. Disassembly Instructions

#### 1.1 Rear of the Cabinet

- Undo 4 screws (A) (Fig. 1, example TVR3740).
- Remove the rear of the cabinet.

#### 1.2 Power Chassis

- Undo screw (B) and 2 screws (C) (Fig. 2).
- Slide the power chassis towards the rear of the TVR and lift it out.
- Unplug the connections if necessary.

#### Safety Note

- Always use an isolating transformer when carrying out repairs.

#### 1.3 Plug-in Unit

- Unplug the connectors on the power chassis (P405, P406, P805) and on the picture tube panel (P901) and untie the cables (Fig. 2).
- Disengage the catch (D) on the bottom of the TVR (Fig. 3).
- Slide the plug-in unit towards the back to gain access to 2 screws (E) (on the left and right, Fig. 4).
- Detach the connector (Fig. 7, PF03) on the keyboard control unit.
- Undo 2 screws (E), (F), (G) (on the left and right) each (Fig. 4).
- Lift the top of the plug-in unit (metal screening and power chassis) and remove the plug-in unit (signal chassis and drive mechanism) towards the back.

**Service Position:** see Fig. 5

- It is not possible to connect the loudspeaker in this service position.

#### Fitting Instruction:

- Before sliding in the plug-in unit from the rear side open the cassette lid so that the cassette lid opener is correctly positioned in front of the cassette lid.

#### 1.3.1 Drive Mechanism

- Undo the screws (I), (J), (K), (L) (Fig. 6).
- Remove the heat sink (M) (Fig. 6).
- Detach the connectors (Fig. 6, PAN01 / PAY01 / PAY02 / PAY03).
- Remove the drive mechanism carefully.

#### 1.3.2 Signal Chassis

- Detach the connectors (Fig. 7, PF01 / PF02) on the keyboard control unit.
- Undo screws (N) (Fig. 6).
- Disengage the catches (O) (Fig. 6).
- Take the signal chassis out of the mounting frame.

#### 1.3.3 Keyboard Control Unit

- Detach the connectors (Fig. 7, PF01 / PF02 / PF03).
- Disengage the catches (P) (Fig. 7).
- Remove the keyboard control unit.

### 2. Important Mains Cable Strain Relief

When re-assembling the TVR, the mains cable has to be locked into the bottom of the cabinet by means of the traction relief as shown in Fig. 8 and laid out on the rear of the cabinet as shown in Fig. 9.

### 3. Important Chassis Connections!

When re-assembling the TVR take care of the chassis connections of the individual components (for example Fig. 10/11).

### 4. Carrying out Measurements

When making measurements on semi-conductors with an oscilloscope, ensure that the test probe is set to 10:1 dividing factor. Further, please note that if the previous measurement was made on an AC input, the coupling capacitor in the oscilloscope will be charged. Discharge via the item being checked can damage components.

### 5. Measured Values and Oscillograms

The measured values given in the circuit diagrams and oscillograms are approximates!

Fig. 10

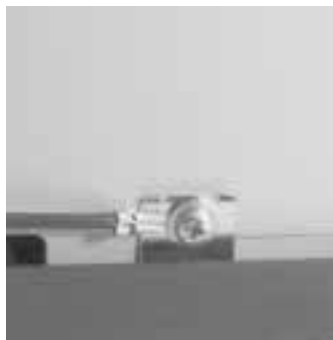



Fig. 11





## Sonderfunktionen

### 1. ATS-Reset

Während dem Einschalten des Gerätes die Fernbedientaste  drücken und gedrückt halten bis das OSD-Dialogfenster "SPRACHAUSWAHL" erscheint. Anschließend ist der ATS-Sender-Suchlauf durchführbar (siehe Bedienungsanleitung).

### 2. Werkseinstellungen

Während dem Einschalten des Gerätes die Fernbedientaste  drücken und gedrückt halten bis das OSD-Dialogfenster "Sonderfunktionen" erscheint. Der Menüpunkt "Werkseinstellungen" ist angewählt und ist noch mit der Taste  zu bestätigen.

Anschließend werden die Grundwerte für Kontrast, Helligkeit, Farbsättigung, Schärfe und Lautstärke eingestellt.

### 3. Kindersicherung



Die Tastenfolge     hebt die persönliche Kennzahl auf.

## Special Functions

### 1. ATS-Reset





Press the remote control button  while switching the TVR on and hold it down until the OSD dialog window "LANGUAGE SELECTION" appears. Subsequently, it is possible to start the ATS system for searching the channels (see user instructions).

### 2. Factory Presets

Press the remote control button  while switching the TVR on and hold it down until the OSD dialog window "SPECIAL FUNCTIONS" appears. The menu option "Factory Preset" is selected and needs only to be confirmed with the  button.

Subsequently, the default values for contrast, brightness, colour saturation, sharpness and volume are set.

### 3. Child Lock

To cancel the personal code number press the buttons     in this order.

# Platinenabbildungen und Schaltpläne / Layout of PCBs and Circuit Diagrams

## Verdrahtungsplan / Wiring Diagram

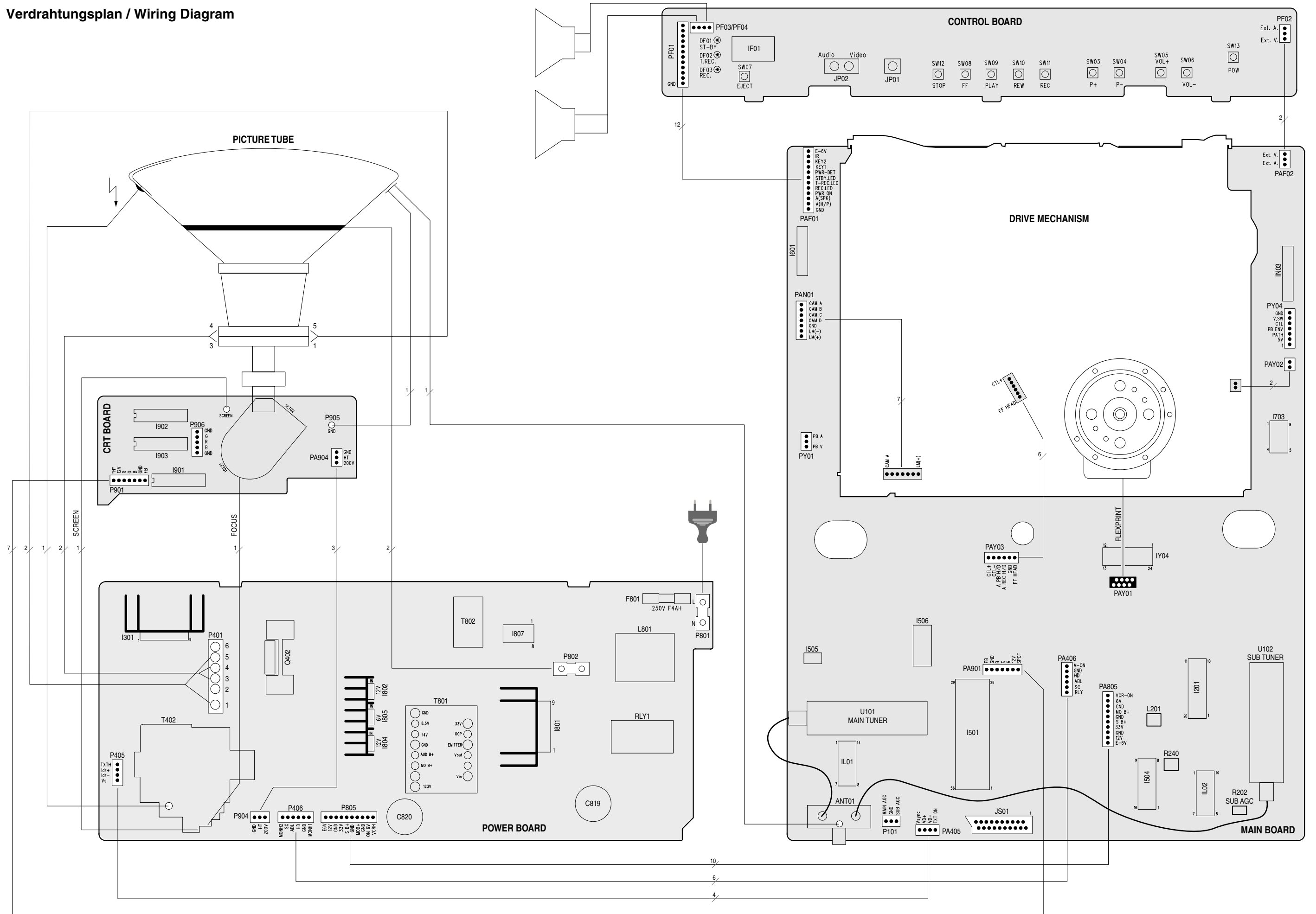

### Leistungschassis/Bildrohrplatte / Power Chassis/Picture Tube PCB

Ansicht von der Lötseite / View of Solder Side

C301	16 F	C406	15 D	C816	7 D	C833	11 E	C910	2 A	D803	5 B	D825	5 F	I807	7 F	J013	16 A	P401	14 D	Q402	13 E	R402	11 F	R422	12 D	R823	11 C	R908	1 B	T402	15 B
C302	16 F	C407	13 B	C817	7 E	C834	10 E	C911	2 C	D804	4 B	D826	5 E	I808	10 F	J016	1 F	P405	17 B	Q403	11 B	R403	11 F	R801	5 D	R830	11 B	R909	1 B	T801	8 B
C305	15 D	C409	12 C	C818	6 C	C835	6 B	C913	1 A	D807	8 D	D827	5 E	I901	2 B	J017	1 F	P406	12 A	Q803	8 A	R404	12 D	R803	4 D	R831	7 F	R910	3 D	T802	8 E
C306	15 D	C410	13 F	C819	5 A	C836	11 D	C914	1 B	D808	8 D	D828	5 E	I902	1 B	J018	8 A	P801A	3 F	Q901	2 A	R406	12 E	R804	5 C	R833	7 C	R911	1 C		
C307	16 E	C413	13 B	C820	10 A	C837	10 D	C915	2 B	D809	7 C	D830	7 F	I903	2 B	J019	1 F	P801B	3 F	R301	16 F	R407	11 F	R805	11 B	R834	6 D	R912	2 C		
C308	16 E	C415	13 F	C822	10 D	C838	11 C	C916	2 B	D810	8 C	D831	9 F	J001	4 D	J020	12 B	P802A	6 E	R302	15 F	R408	16 D	R807	8 D	R835	7 E	R913	2 A		
C309	14 F	C416	14 D	C823	6 E	C840	7 F	D301	15 D	D811	10 D	D901	2 A	J002	12 B	L301	16 E	P802B	6 E	R304	15 E	R409	12 F	R808	8 C	R836	10 F	R914	2 A		
C310	15 D	C418	16 D	C824	11 A	C841	5 F	D302	15 D	D812	9 A	D902	2 A	J004	10 A	L302	16 E	P805	12 A	R306	15 E	R410	13 C	R810	7 D	R843	8 A	RLY1	4 C		
C311	15 E	C801	4 F	C825	9 E	C842	5 E	D401	13 A	D813	10 B	D903	2 A	J005	10 A	L401	12 D	P901	3 A	R310	15 F	R412	13 B	R811	7 C	R901	2 B	RLY2	12 C		
C312	15 E	C803	5 B	C826	11 D	C846	9 F	D402	12 F	D814	10 C	D904	2 A	J007	12 B	L403	12 D	P904	13 A	R311	15 F	R413	12 B	R812	5 B	R902	1 B	SCT01	2 D		
C313	15 F	C804	5 C	C827	10 E	C904	2 B	D403	12 B	D815	9 E	F801	4 F	J008	13 C	L404	14 E	P905	1 F	R312	14 F	R415	2 F	R813	4 A	R903	2 B	SCT02	1 E		
C401	12 E	C807	7 C	C828	10 B	C905	1 B	D405	12 A	D819	11 B	I301	15 F	J009	6 F	L801	4 E	P906	1 C	R313	15 E	R418	12 F	R815	8 E	R904	2 B	SG001	1 C		
C402	12 E	C808	8 D	C829	10 C	C907	2 C	D406	12 B	D822	7 F	I801	7 C	J010	5 C	L802	7 B	PA904	2 F	R314	15 E	R419	13 A	R816	7 D	R905	1 B	SG002	1 E		
C403	12 E	C810	8 A	C830	10 F	C908	1 C	D801	4 B	D823	3 C	I802	11 D	J011	6 B	L803	9 A	Q301	14 F	R315	15 D	R420	14 F	R817	6 B	R906	1 B	SG003	1 F		
C404	12 E	C813	11 A	C832	11 D	C909	1 B	D802	4 B	D824	8 F	I806	9 F	J012	10 E	L805	10 B	Q401	11 E	R401	11 F	R421	12 A	R819	10 B	R907	2 C	T401	12 E		

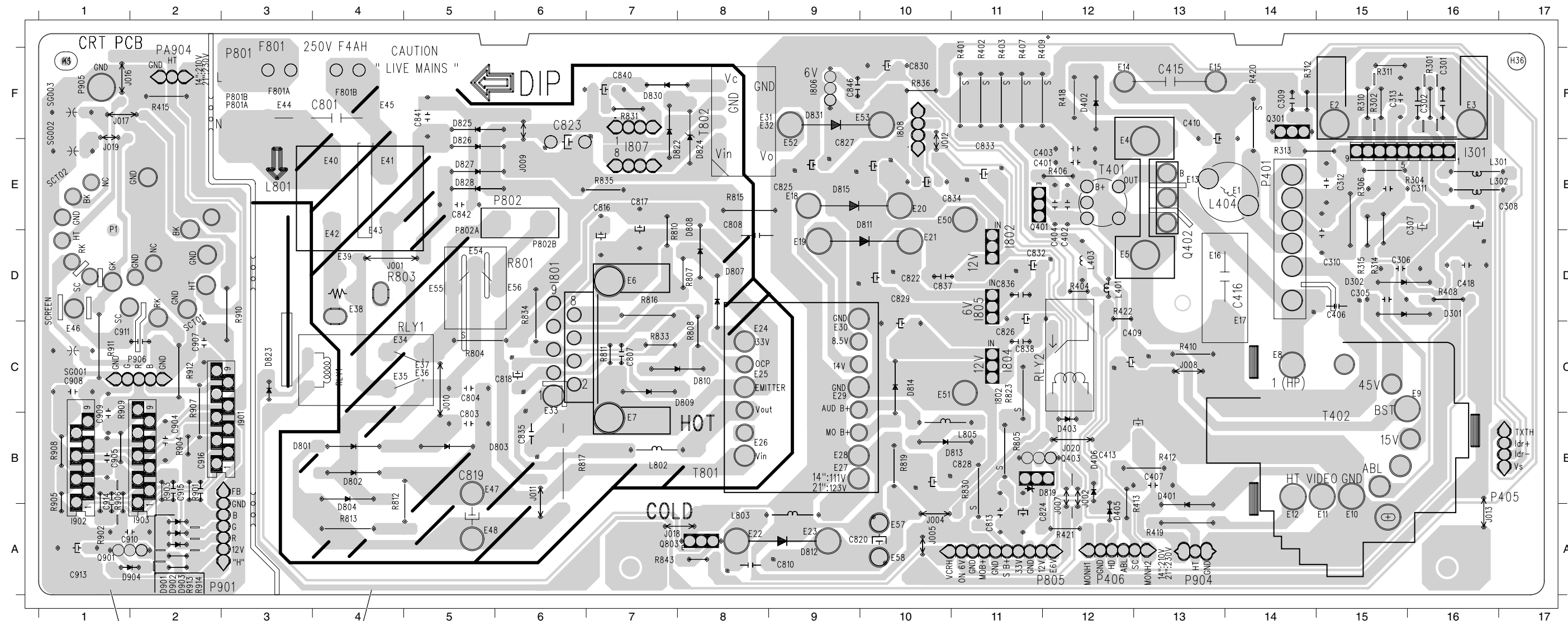

Bildrohrplatte  
Picture Tube PCB

Leistungschassis  
Power Chassis



Leistungschassis / Power Chassis (PS)

Reference	CO	17	TU2	23
Oscillograms	HA	18	VS	25
PS	DE	19	TM	27
CRT	TV	21		

C301	G15	C313	F17	C415	F19	C816	E6	C827	F10	C838	D11	D405	B16	D811	F9	D826	H5	I805	F10	L802	D7	Q301	F16	R311	F18	R407	D15	R421	C15	R812	G7	R834	B7
C302	F15	C401	D15	C416	E18	C817	E6	C828	D10	C840	H7	D406	C16	D812	C10	D827	H5	I806	H10	L803	C9	Q401	E15	R312	F15	R408	C20	R422	B15	R813	G7	R835	H6
C305	D19	C402	E15	C418	B20	C818	C6	C829	D10	C841	H5	D801	G5	D813	E9	D828	H5	I807	G6	L805	E9	Q402	E18	R313	F16	R409	D16	R801	G2	R815	B8	R836	I10
C306	C18	C403	D15	C801	F2	C819	F6	C830	H11	C842	H5	D802	F5	D814	D9	D830	H8	I808	E14	L901	G1	Q403	D14	R314	G17	R410	C18	R803	G4	R816	D6	R843	I2
C307	F17	C404	E16	C803	G5	C820	C10	C832	F11	C846	H12	D803	G5	D815	F9	D831	H9	L301	G15	P401	F21	Q803	H2	R315	F17	R412	B19	R804	F4	R817	B7	RLY1	H3
C308	F16	C406	D19	C804	F5	C822	F10	C833	F11	D301	D19	D804	G5	D819	B10	F801	F2	L302	F15	P405	A14	R301	G15	R401	D15	R413	B18	R805	C11	R819	C10	RLY2	C14
C309	F16	C407	B19	C807	B6	C823	H7	C834	D14	D302	C18	D807	F7	D822	H8	I301	G17	L401	D15	P406	A15	R302	G17	R402	D15	R415	B20	R807	F7	R823	C11	T401	D16
C310	F19	C409	D19	C808	B8	C824	B10	C835	C6	D401	B19	D808	F7	D823	H3	I801	C5	L403	C15	P805	A11	R304	G16	R403	D16	R418	F19	R808	E7	R830	C11	T402	E20
C311	F17	C410	F19	C810	C10	C825	H10	C836	F11	D402	F19	D809	C6	D824	H8	I802	F10	L404	F20	P904	A19	R306	G20	R404	D13	R419	C19	R810	E3	R831	H7	T801	G8
C312	G18	C413	B20	C813	B10	C826	D11	C837	F11	D403	D14	D810	E7	D825	H5	I804	D10	L801	F3	PWC1	F1	R310	F17	R406	D16	R420	F20	R811	B6	R833	C7	T802	H8

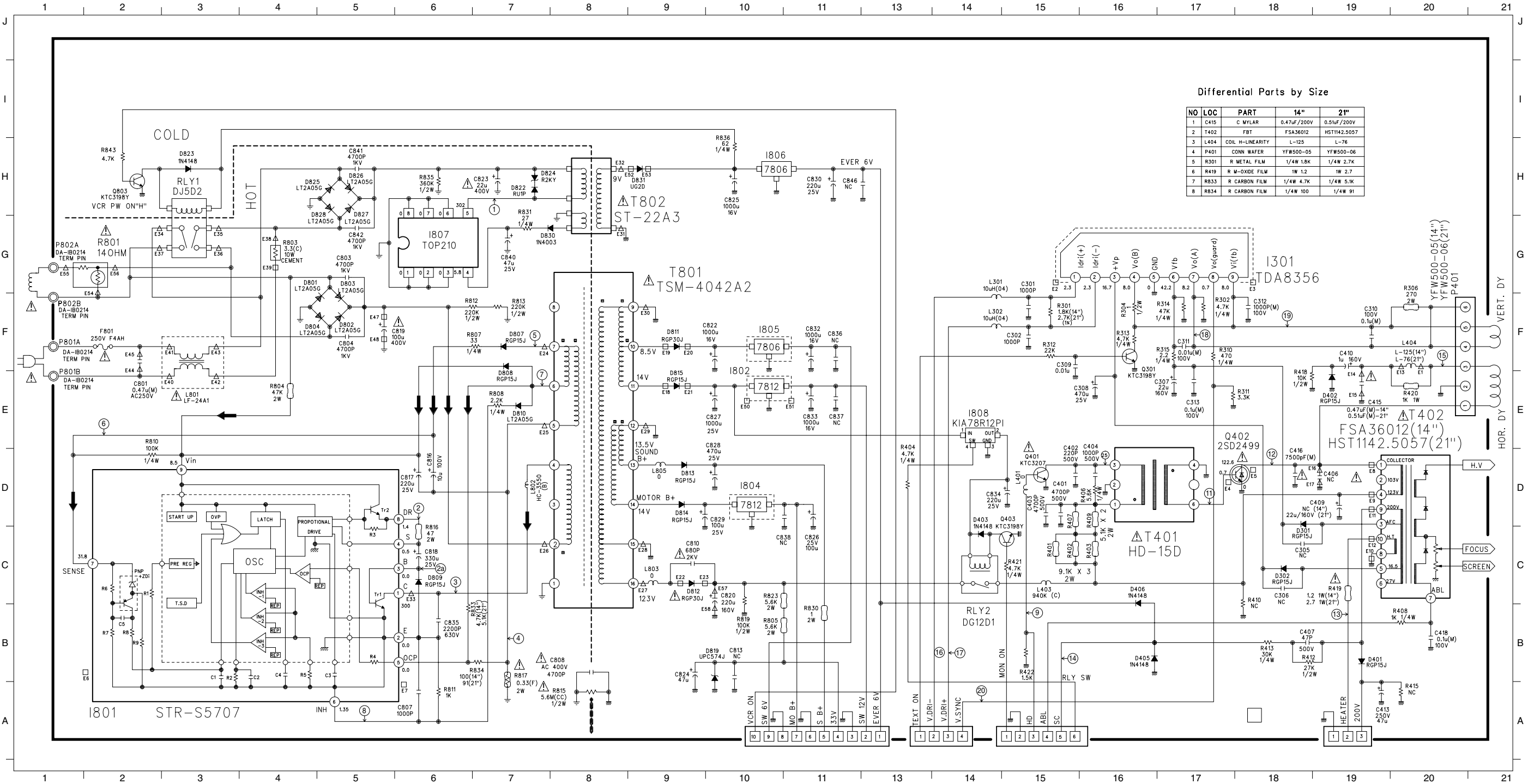

Bildrohrplatte / Tube PCB (CRT)

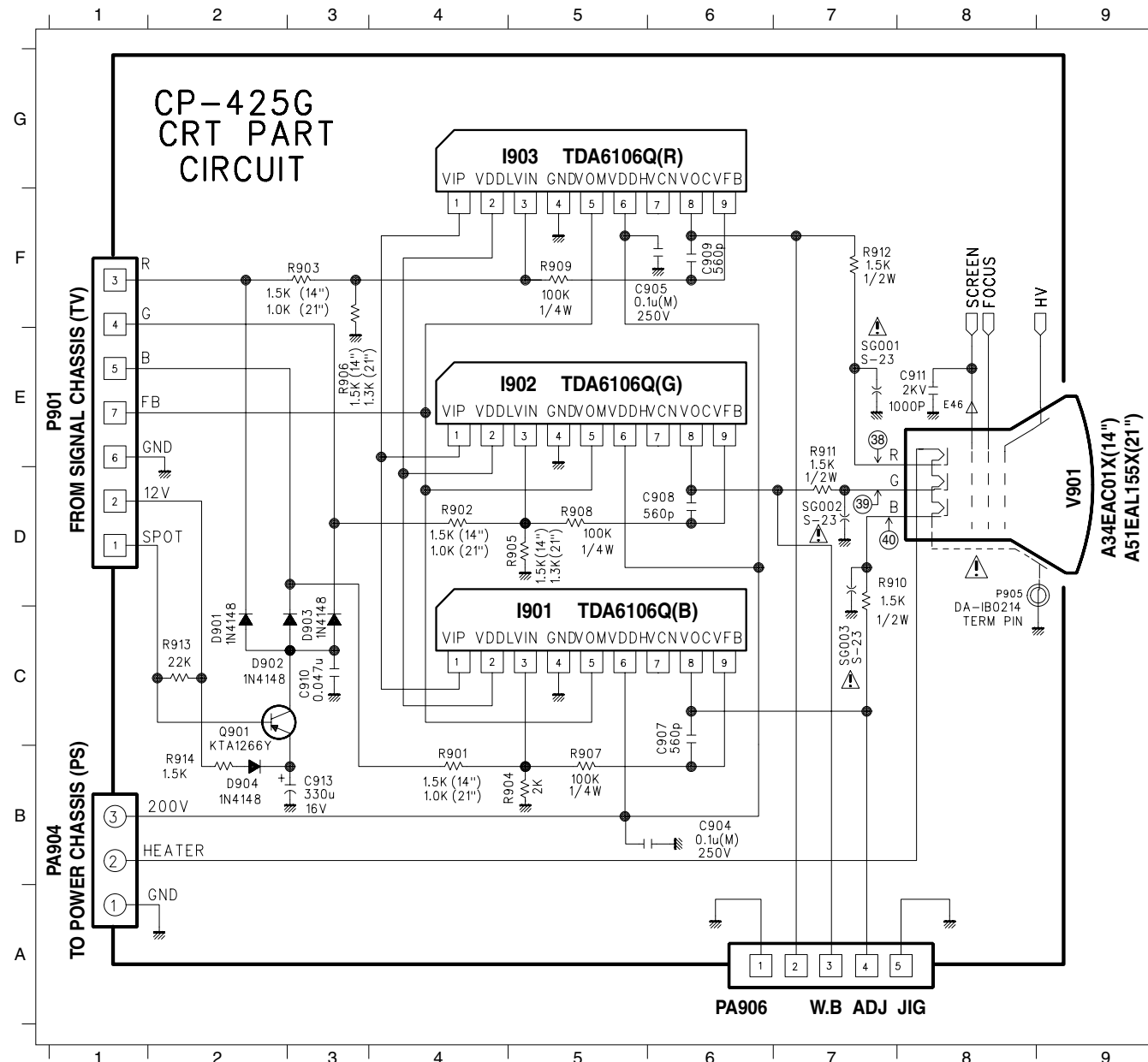

Component list table with columns for component type (C, D, P, R), value, and reference designator.

Reference table with columns for CO, HA, PS, CRT, DE, TV, TU2, and TM.

Signalchassis / Signal Chassis

Ansicht von der Lötseite / View of Solder Side

Large component list table for the signal chassis, organized in columns for component type and reference designator.

Large component list table for the tube PCB, organized in columns for component type and reference designator.

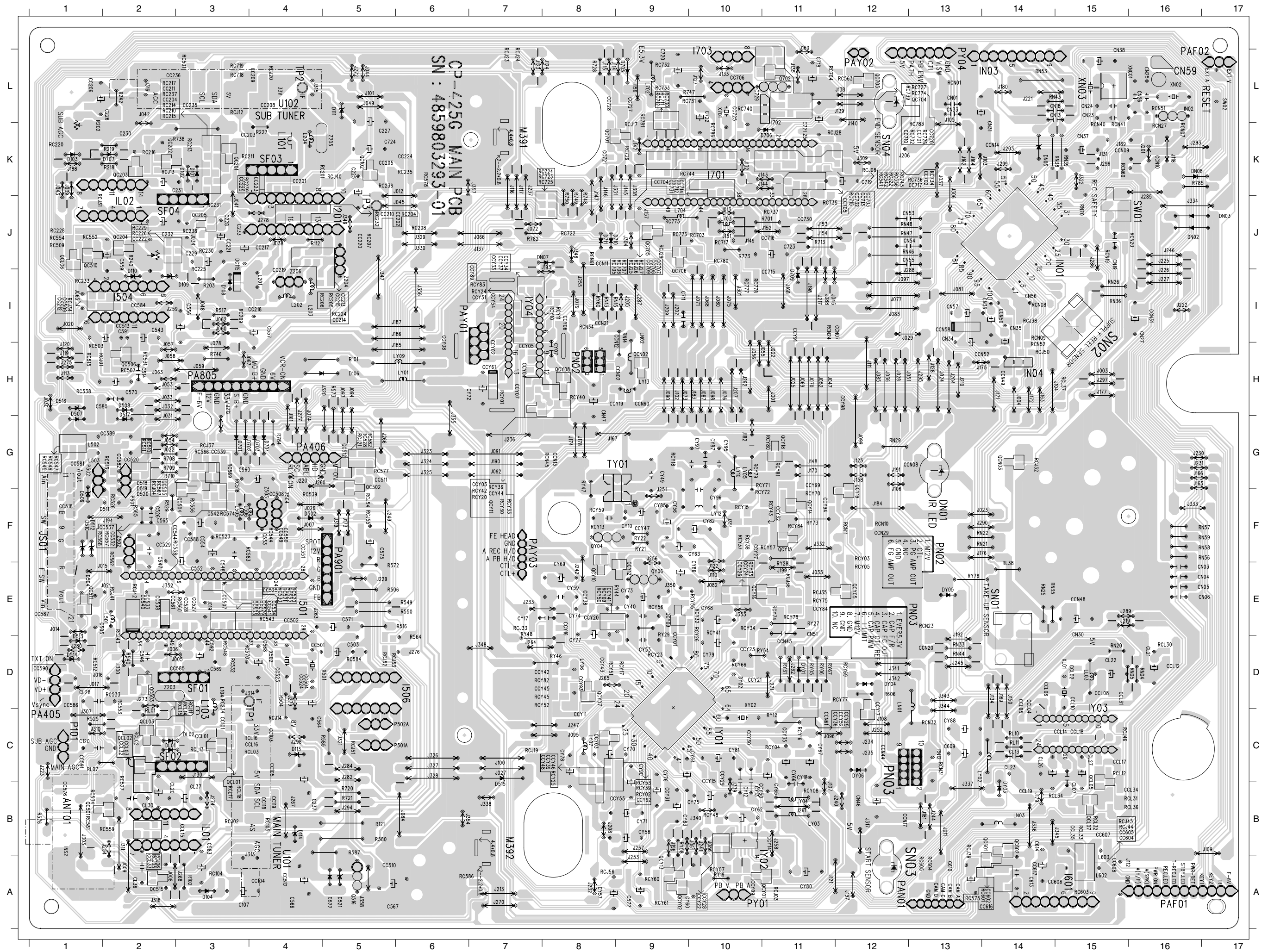

Signalchassis – TV-Steuerung / Signal Chassis – TV Control (CO)

Reference	CO	TU2	23
Oscillograms	HA	VS	25
PS	DE	TM	27
CRT	TV		21

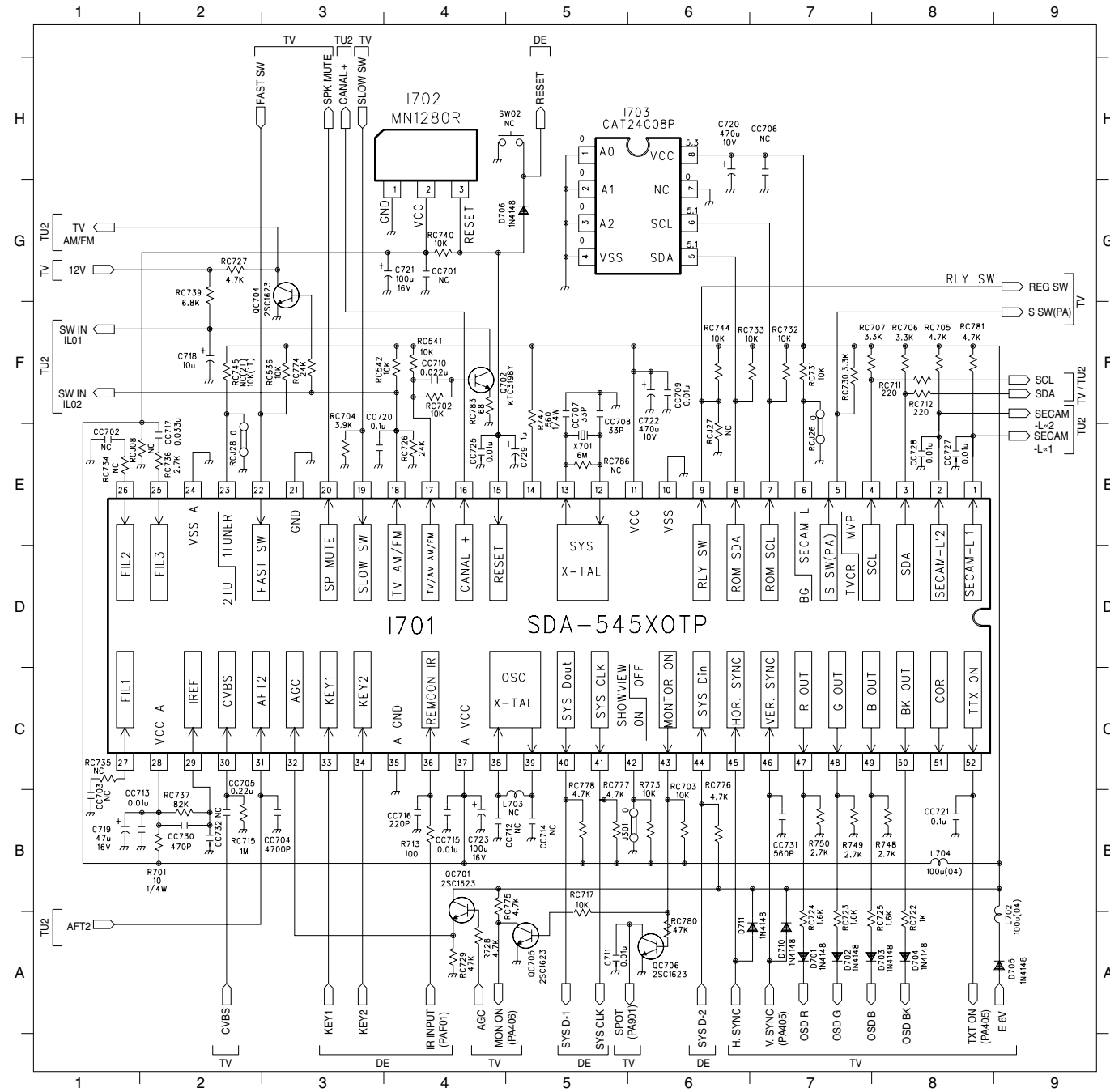

C711	A5	CC704	B3	CC716	B4	D702	A7	L702	B9	R747	F5	RC705	F8	RC726	E4	RC739	G2	RC783	F4
C718	F2	CC705	B2	CC717	F2	D703	A8	L703	B5	R748	B8	RC706	F8	RC727	G2	RC740	G4	RC786	E5
C719	B1	CC706	H7	CC720	E3	D704	A8	L704	B8	R749	B7	RC707	F8	RC729	A4	RC744	F6	RCJ08	E2
C720	H6	CC707	F5	CC721	B8	D705	A9	Q702	F4	R750	B7	RC711	F8	RC730	F7	RC745	F2	RCJ26	E7
C721	G4	CC708	F5	CC725	E4	D706	G5	QC701	B4	R773	B6	RC712	F8	RC731	F7	RC774	F3	RCJ27	E6
C722	F6	CC709	F6	CC727	E8	D710	A7	RC536	G3	RC536	F3	RC715	B2	RC732	F7	RC775	B4	RCJ28	E2
C723	B4	CC710	F4	CC728	E8	D711	A7	QC705	A5	RC541	F4	RC717	B5	RC733	F7	RC776	B6	SW02	H5
C729	E5	CC712	B5	CC730	B2	D710	D4	I701	D4	RC542	F4	RC722	A8	RC734	E1	RC777	B5	X701	E5
CC701	G4	CC713	B2	CC731	B7	I702	H4	R701	B2	RC702	F4	RC723	A7	RC735	C1	RC778	B5		
CC702	F1	CC714	B5	CC732	B2	I703	H6	R713	B4	RC724	A7	RC724	A7	RC736	E2	RC780	A6		
CC703	B1	CC715	B4	D701	A7	J301	B6	R728	A4	RC704	E3	RC725	A8	RC737	B2	RC781	F8		

Signalchassis – Kopfverstärker / Signal Chassis – Head Amplifier (HA)

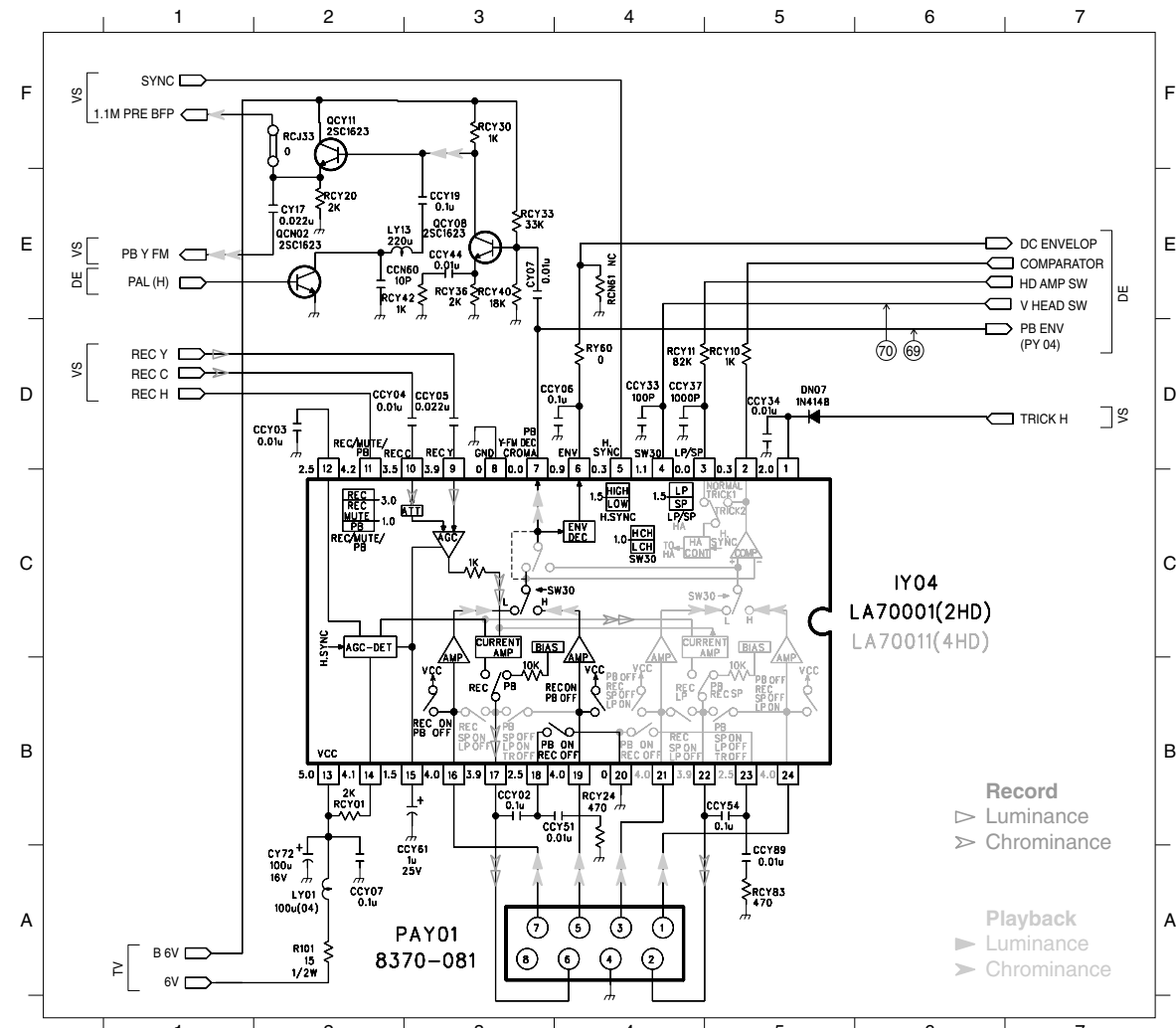

CCN60	E2	CCY44	E3	LY13	E3	RCY20	E2
CCY02	B3	CCY51	B4	PAY01	A4	RCY24	B4
CCY03	D2	CCY54	B5	RCN02	E2	RCY30	F3
CCY04	D3	CCY61	B3	QCY08	E3	RCY33	E3
CCY05	D3	CCY89	B5	QCY11	F2	RCY36	E3
CCY06	D4	CY07	E4	R101	A2	RCY40	E3
CCY07	B2	CY17	E2	RCJ33	F2	RCY42	E3
CCY19	E3	CY72	B2	RCN61	E4	RCY83	A5
CCY33	D4	DN07	D5	RCY01	B2	RY60	D4
CCY34	D5	IY04	C5	RCY10	D5		
CCY37	D4	LY01	A2	RCY11	D5		

# Signalchassis – Laufwerksteuerung / Signal Chassis – Drive Control (DE)

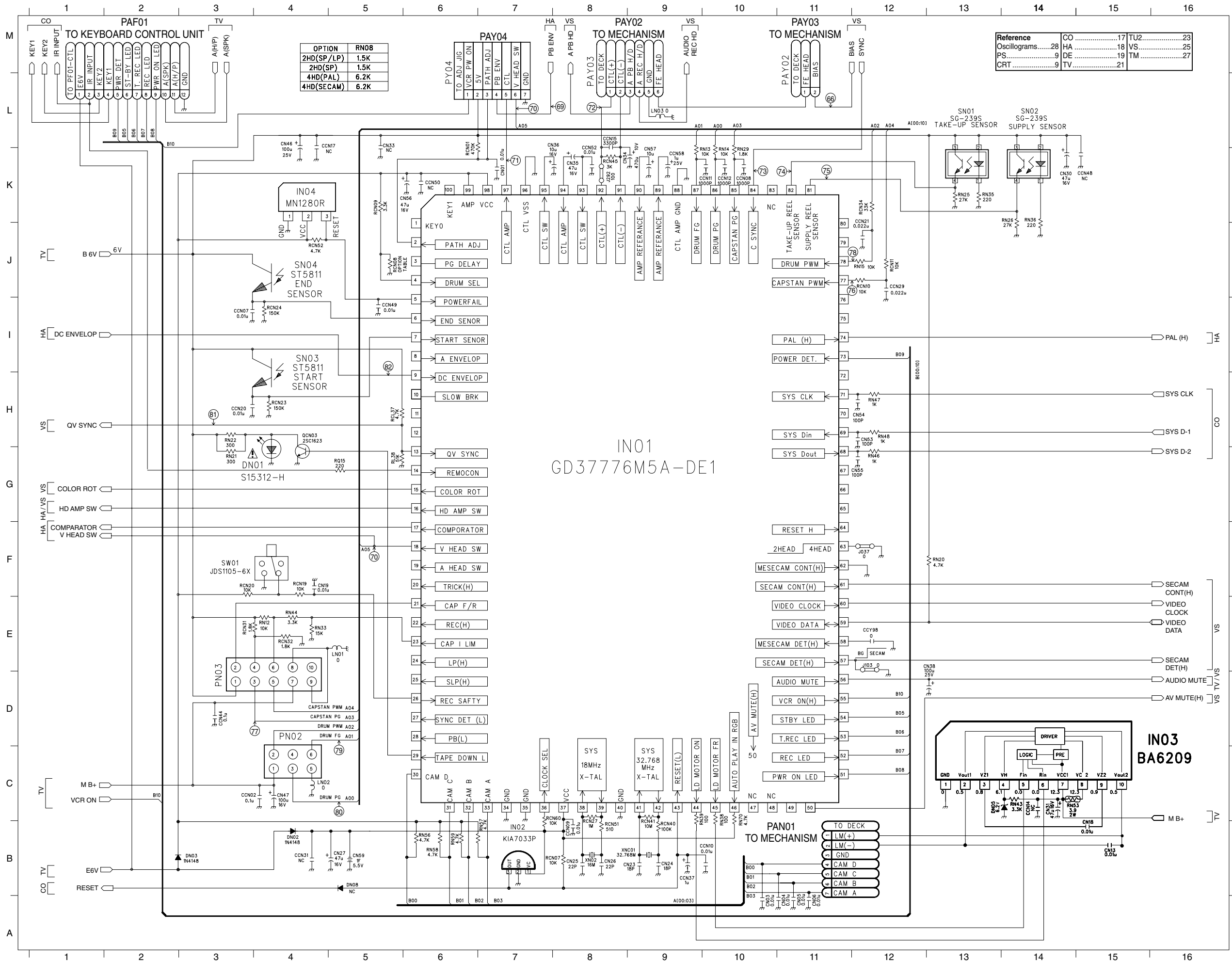

OPTION	RN08
2HD(SP/LP)	1.5K
2HD(SP)	1.5K
4HD(PAL)	6.2K
4HD(SECAM)	6.2K

Reference	CO	TU2
Oscillograms	17	23
PS	9	25
CRT	9	27

- CCN02 C 4
- CCN07 I 3
- CCN08 K 10
- CCN09 B 8
- CCN10 B 9
- CCN11 K 10
- CCN12 K 10
- CCN14 C 14
- CCN15 L 8
- CCN17 L 4
- CCN20 H 3
- CCN21 J 12
- CCN29 J 12
- CCN31 B 4
- CCN37 B 9
- CCN44 D 3
- CCN48 K 15
- CCN49 I 5
- CCN50 K 6
- CCN52 K 8
- CCN58 K 9
- CCY98 E 12
- CN01 K 7
- CN03 B 10
- CN04 B 11
- CN05 B 11
- CN06 B 11
- CN13 C 14
- CN13 B 15
- CN18 B 15
- CN19 F 4
- CN23 B 9
- CN24 B 9
- CN25 B 8
- CN26 B 8
- CN27 B 5
- CN30 K 14
- CN31 C 14
- CN33 L 5
- CN34 K 9
- CN35 K 8
- CN36 K 8
- CN37 B 9
- CN38 D 13
- CN46 L 4
- CN47 C 4
- CN53 H 12
- CN54 H 12
- CN55 G 12
- CN56 K 6
- CN57 K 9
- CN59 B 5
- DN01 G 4
- DN02 B 4
- DN03 B 3
- DN05 C 14
- DN08 B 5
- IN01 J 6
- IN02 B 7
- IN03 D 15
- IN04 K 4
- J037 F 12
- J103 E 12
- J292 K 8
- LN01 E 4
- LN02 C 4
- LN03 L 9
- PAN01 C 15
- PAY02 L 11
- PAY03 L 8
- PN02 C 4
- PN03 D 4
- PY04 L 6
- QCN03 G 4
- RCL37 H 5
- RCN01 L 6
- RCN07 B 8
- RCN08 J 5
- RCN09 K 5
- RCN10 J 12
- RCN11 J 12
- RCN19 F 4
- RCN20 F 3
- RCN23 H 4
- RCN24 I 4
- RCN27 C 8
- RCN31 E 4
- RCN32 E 4
- RCN34 K 12
- RCN40 B 9
- RCN41 C 9
- RCN45 K 8
- RCN51 B 8
- RCN52 J 4
- RCN60 B 7
- RL38 G 5
- RN12 E 4
- RN13 K 9
- RN14 K 10
- RN15 J 12
- RN20 F 13
- RN21 G 3
- RN22 H 3
- RN25 K 13
- RN26 J 14
- RN29 K 10
- RN33 E 4
- RN35 K 13
- RN36 J 14
- RN38 B 10
- RN39 B 9
- RN43 C 14
- RN44 E 4
- RN46 G 12
- RN47 H 12
- RN48 H 12
- RN53 C 14
- RN56 B 6
- RN57 B 6
- RN58 B 6
- RN59 B 6
- RN70 B 10
- RQ15 G 5
- SN01 K 13
- SN02 K 14
- SN03 H 3
- SN04 J 4
- SN05 F 4
- SN06 B 8
- XNC01 B 9

### Signalchassis – TV-Signalelektronik / Signal Chassis – TV Signal Electronic (TV)

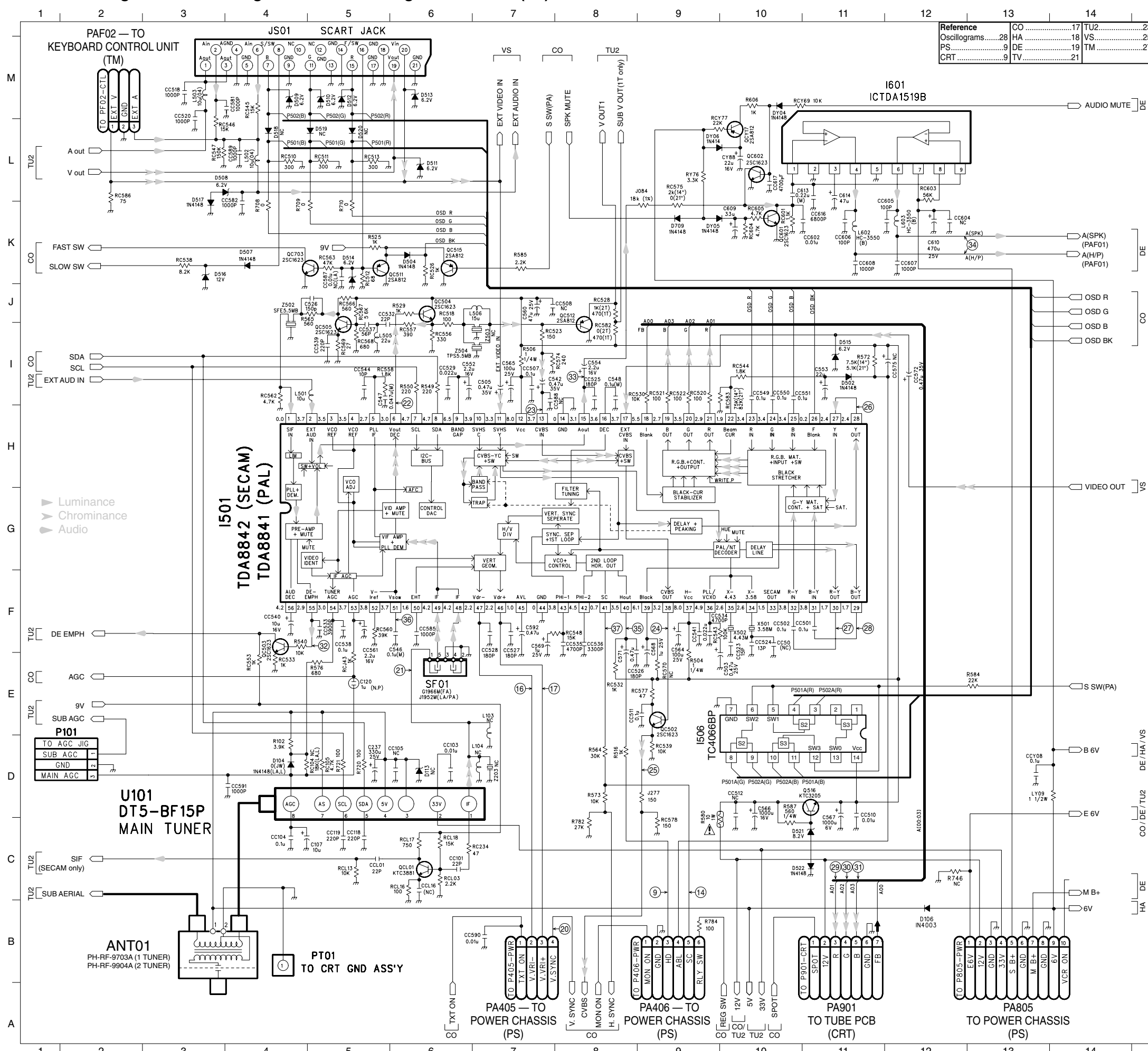

Reference	CO	TU2
Oscilloscopes	17	23
PS	18	25
CRT	19	27
	21	

ANT01	B 3	D522	C 11	RC546	M 4
C107	C 5	D709	K 9	RC547	L 4
C120	E 5	DY04	M 10	RC548	F 8
C237	D 5	DY05	K 10	RC553	F 4
C503	F 10	DY06	L 10	RC556	J 6
C505	I 7	I501	G 4	RC557	J 6
C526	J 5	I505	D 11	RC558	I 6
C542	I 8	I506	E 10	RC560	F 5
C546	F 6	I601	L 12	RC562	I 4
C547	I 6	J084	L 9	RC563	K 5
C548	I 8	J277	C 9	RC565	J 5
C552	I 7	J501	N 5	RC567	J 5
C553	I 11	L103	E 7	RC568	J 5
C554	I 8	L104	D 7	RC569	I 5
C560	J 7	L501	I 5	RC570	F 9
C564	F 9	L502	L 4	RC574	I 8
C565	I 7	L503	M 3	RC575	L 9
C566	D 10	L505	I 5	RC577	E 9
C567	D 11	L506	J 7	RC578	D 9
C568	F 9	L602	K 11	RC582	J 8
C569	F 8	L603	K 12	RC583	I 10
C571	F 9	LY09	D 14	RC586	L 2
C592	F 7	P101	D 2	RC601	K 11
C609	K 10	P501(B)	L 4	RC603	L 12
C610	K 12	P501A(B)D	11	RC604	K 10
C613	L 11	P501(G)	L 5	RC605	K 10
C614	L 11	P501A(G)D	10	RCJ43	F 5
CC101	C 6	P501(R)	L 5	RCL03	C 6
CC103	D 6	P501A(R)E	11	RCL13	C 5
CC104	C 4	P502(B)	M 4	RCL16	C 6
CC105	D 6	P502A(B)D	10	RCL17	C 6
CC118	C 5	P502(G)	M 5	RCL18	C 6
CC119	C 5	P502A(G)D	10	RCY69	M 11
CC501	F 11	P502(R)	M 5	RCY77	M 10
CC502	F 11	P502A(R)E	11	RY76	L 9
CC504	F 10	PA405	B 7	SF01	F 7
CC507	I 7	PA406	B 9	U101	D 4
CC508	J 8	PA805	B 13	X501	F 10
CC510	D 11	PA901	B 11	X502	F 10
CC511	E 9	PAF02	M 2	Z203	D 7
CC512	D 10	PT01	A 4	Z502	J 4
CC518	M 3	QC502	E 9	Z503	J 7
CC520	M 3	QC503	F 4	Z504	I 7
CC523	F 10	QC504	J 6		
CC524	F 10	QC505	J 5		
CC525	I 8	QC511	K 5		
CC526	F 9	QC512	J 8		
CC527	F 7	QC515	K 6		
CC528	F 7	QC601	K 10		
CC529	I 6	QC602	L 10		
CC532	J 6	QC703	K 5		
CC533	F 5	QCL01	C 6		
CC534	F 10	QCY17	M 10		
CC535	F 8	R102	E 4		
CC536	F 8	R504	F 9		
CC537	J 5	R506	I 7		
CC538	F 5	R516	D 9		
CC539	I 5	R525	K 5		
CC540	F 4	R529	J 6		
CC541	F 9	R540	F 5		
CC544	I 5	R549	I 6		
CC549	I 10	R550	I 6		
CC550	I 10	R564	D 8		
CC551	I 11	R565	J 5		
CC561	F 5	R572	I 12		
CC572	I 12	R573	D 8		
CC575	I 12	R576	F 5		
CC581	M 4	R580	D 9		
CC582	L 4	R584	E 13		
CC585	F 6	R585	K 7		
CC587	K 5	R587	C 10		
CC588	I 8	R606	M 10		
CC589	L 4	R708	L 4		
CC590	B 7	R709	L 5		
CC591	D 4	R710	L 5		
CC602	K 11	R720	D 5		
CC604	K 12	R721	D 5		
CC605	K 12	R746	C 13		
CC606	K 11	R782	C 8		
CC607	K 12	R784	B 9		
CC608	K 11	RC104	D 5		
CC616	L 11	RC105	D 5		
CC617	L 10	RC234	C 7		
CCL01	C 5	RC510	L 4		
CCL16	C 6	RC511	L 5		
CCY08	D 13	RC512	K 5		
CY88	L 10	RC513	L 5		
D104	D 4	RC518	J 6		
D106	B 12	RC520	I 10		
D113	D 6	RC521	I 9		
D502	I 11	RC522	I 9		
D504	K 6	RC523	J 8		
D507	K 4	RC526	K 6		
D513	L 6	RC528	J 8		
D514	K 5	RC530	I 9		
D515	I 11	RC532	E 8		
D516	K 3	RC533	F 4		
D517	L 3	RC538	K 3		
D518	M 4	RC539	D 9		
D519	M 5	RC543	F 10		
D520	M 5	RC544	I 10		
D521	C 11	RC545	M 4		

Signalchassis – Empfangseinheit 2/SECAM-L-Demodulator (TU2)

Signal Chassis – Frontend 2/SECAM L Demodulator (TU2)

Reference	CO	TV2	TV2
Oscillograms	HA	VS	VS
PS	DE	TM	TM
CRT	TV		

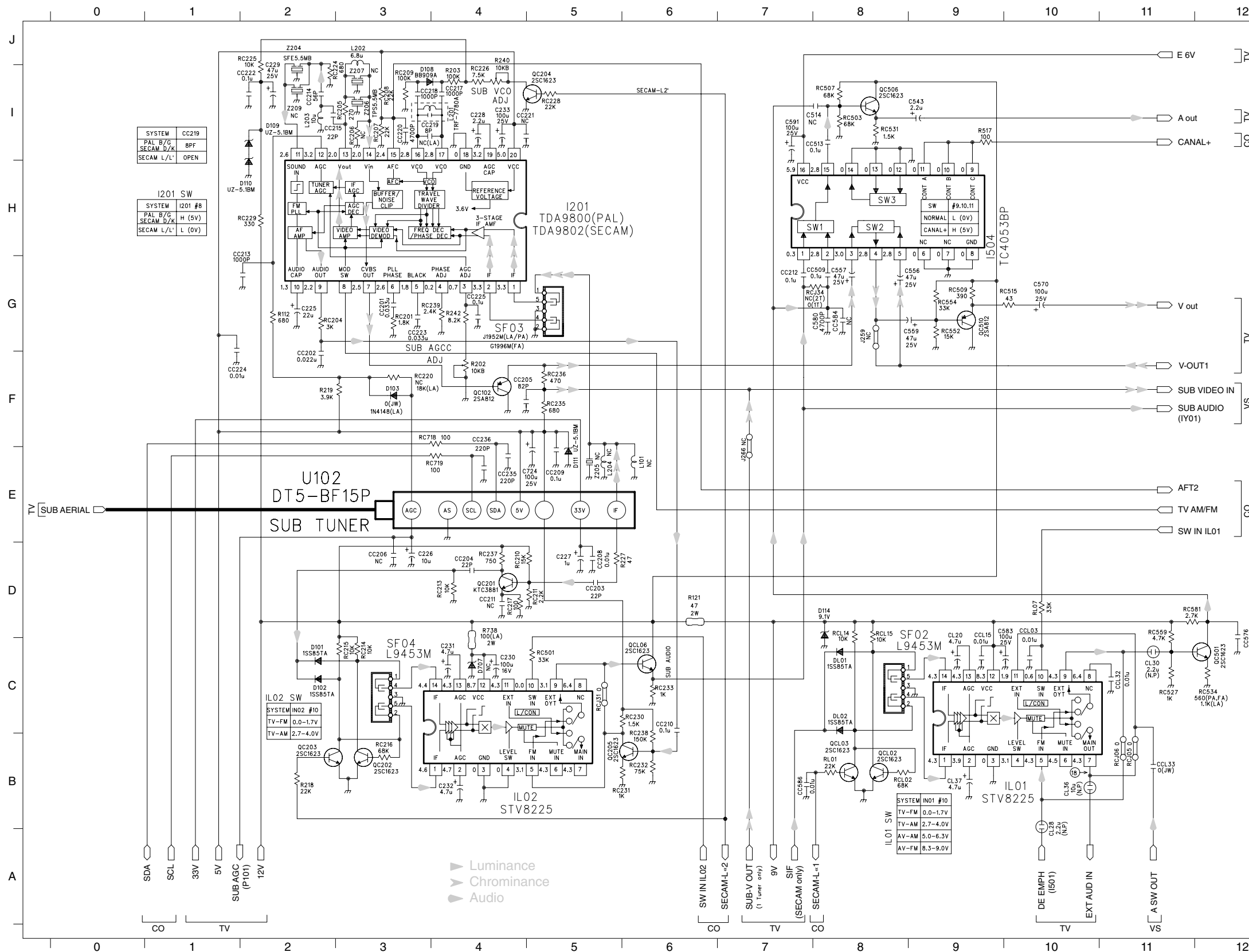

C225	G2	L101	E6	RC727	F8
C226	D3	L201	I4	RC730	F8
C227	D5	L202	I3	RC745	E8
C228	I4	L203	I2	RC774	F8
C229	I2	L204	E5	RC783	E10
C230	C4	Q702	E10	RCJ05	B11
C231	C4	QC102	F4	RCJ06	B11
C232	B4	QC201	D4	RCJ28	E9
C233	I4	QC202	B3	RCJ31	C5
C514	I8	QC203	B2	RCJ34	G7
C543	I9	QC204	I5	RCL02	B8
C556	G8	QC205	B6	RCL14	D8
C557	G8	QC501	C12	RCL15	D8
C559	G8	QC506	I8	RL01	B8
C570	G10	QC510	G9	RL07	D10
C580	G8	QC704	F8	SF02	C8
C583	C9	QCL02	B8	SF03	G5
C591	I7	QCL03	B8	SF04	C3
C718	E8	QCL06	C6	U102	E3
C724	E5	R112	G2	Z204	I2
CC201	G3	R121	D6	Z205	E5
CC202	F2	R202	F4	Z206	I3
CC203	D5	R203	I4	Z207	I3
CC204	D4	R218	B2	Z209	I2
CC205	F4	R219	F3		
CC206	D3	R227	D5		
CC208	D5	R240	I4		
CC209	E5	R242	G4		
CC210	C6	R517	I9		
CC211	D4	R738	D4		
CC212	G7	RC201	G3		
CC213	G2	RC204	G2		
CC214	I2	RC205	I3		
CC215	I2	RC206	I3		
CC217	I4	RC207	I3		
CC218	I3	RC208	I3		
CC219	I3	RC209	I3		
CC220	I3	RC210	D5		
CC221	I4	RC211	D5		
CC222	I2	RC213	D4		
CC223	G3	RC214	C3		
CC224	G1	RC215	C3		
CC225	G4	RC216	B3		
CC235	E4	RC217	D4		
CC236	E4	RC220	F3		
CC509	G8	RC224	I2		
CC513	I8	RC225	I2		
CC576	D12	RC226	I4		
CC584	G8	RC228	I5		
CC586	B7	RC229	H2		
CC716	E9	RC230	C5		
CC720	E9	RC231	B5		
CCL03	C10	RC232	B6		
CCL15	C9	RC233	C6		
CCL32	C11	RC235	F5		
CCL33	B11	RC236	F5		
CL20	C9	RC237	D4		
CL28	B10	RC238	C6		
CL30	C11	RC239	G4		
CL36	B10	RC501	C5		
CL37	B9	RC503	I8		
DL01	C2	RC507	I8		
DL02	C2	RC509	G9		
DL102	C2	RC515	G9		
DL103	F3	RC527	C11		
DL108	I3	RC531	I8		
DL109	I2	RC534	C12		
DL110	H2	RC536	E8		
DL111	E5	RC541	E9		
DL114	D8	RC542	E9		
D707	C4	RC552	G9		
DL01	C8	RC554	G9		
DL02	C8	RC559	D11		
I201	H4	RC581	D11		
I504	H7	RC702	E9		
IL01	C9	RC718	F4		
IL02	C4	RC719	E4		
J259	G8	RC726	E9		
J266	E7				

### Signalchassis – VCR-Signalelektronik / Signal Chassis – VCR Signal Electronic (VS)

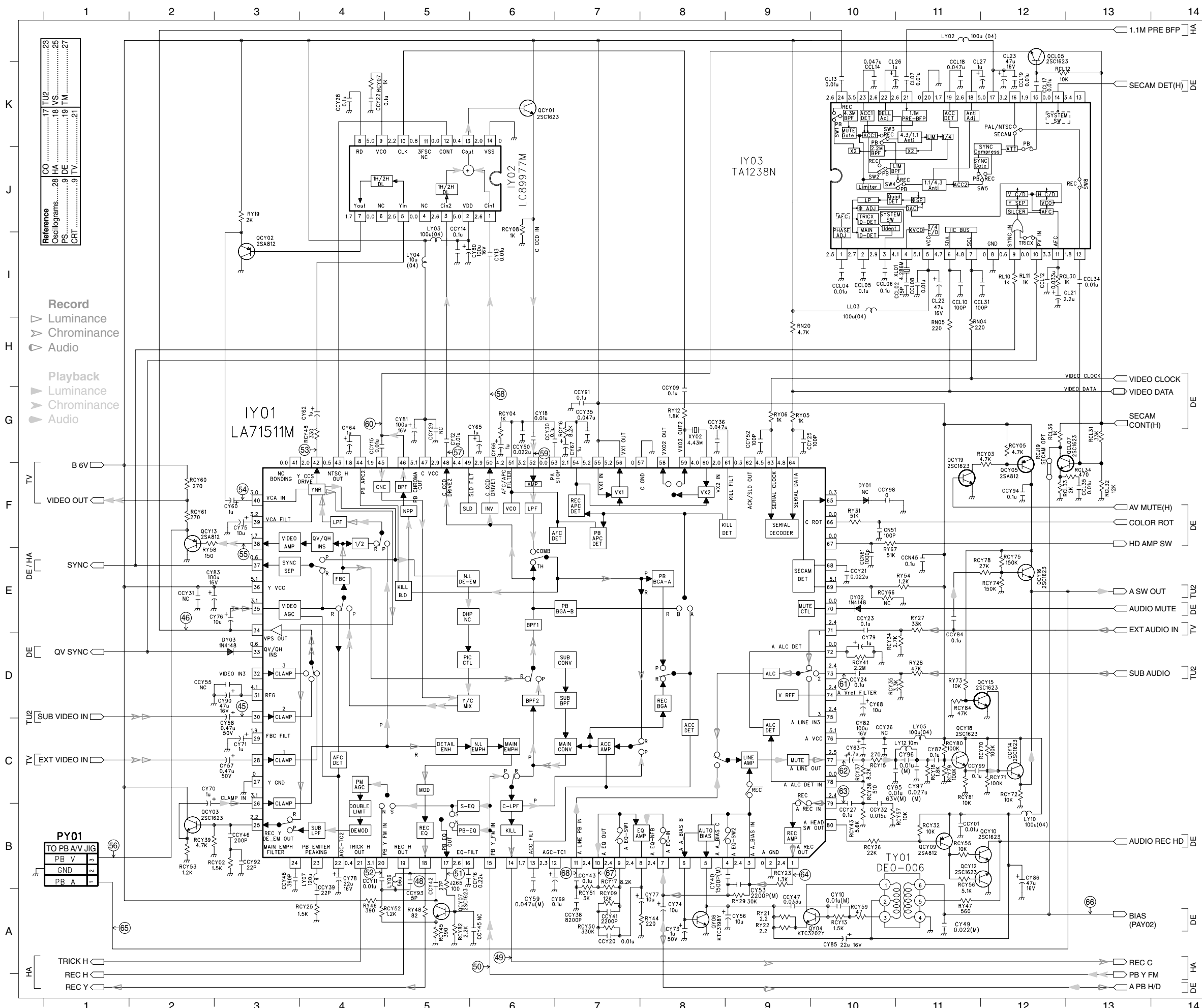

CCL02	I 11	CY81	G 5	RCY78	E 12
CCL04	I 10	CY82	C 10	RCY79	C 11
CCL05	I 10	CY83	E 3	RCY80	C 11
CCL06	I 10	CY85	A 10	RCY81	C 11
CCL08	I 11	CY86	B 12	RCY82	A 5
CCL10	I 11	CY87	C 11	RCY84	E 11
CCL12	I 12	CY90	D 3	RL10	I 12
CCL14	K 10	CY95	C 11	RL11	I 12
CCL17	K 12	CY96	C 11	RN04	H 11
CCL18	K 11	CY97	C 11	RN05	H 11
CCL19	K 12	DY01	F 10	RN20	H 9
CCL31	I 12	DY02	E 10	RY05	G 9
CCL34	I 13	DY03	D 3	RY06	G 9
CCL35	F 13	IY01	B 9	RY12	G 8
CCN45	E 11	IY02	J 6	RY19	J 3
CCN61	E 10	IY03	J 10	RY21	A 9
CCY01	B 11	J265	B 5	RY22	A 9
CCY09	H 8	LL03	G 11	RY27	E 11
CCY11	B 4	LY02	L 11	RY28	D 11
CCY14	I 5	LY03	I 5	RY29	A 9
CCY15	G 4	LY04	I 5	RY31	F 10
CCY16	B 5	LY05	C 11	RY44	A 8
CCY20	A 7	LY06	B 5	RY46	A 4
CCY21	E 10	LY07	B 4	RY47	A 11
CCY22	K 4	LY10	B 13	RY48	A 5
CCY23	E 10	LY12	C 11	RY54	E 11
CCY24	D 10	PY01	B 1	RY58	F 2
CCY25	G 9	QCL05	L 12	RY67	F 10
CCY26	C 10	QCL07	G 13	RY73	D 13
CCY27	B 10	QCY01	K 6	TY01	B 11
CCY28	K 4	QCY02	I 3	XL01	B 11
CCY29	G 5	QCY03	B 2	XY02	G 8
CCY30	G 6	QCY05	F 12		
CCY31	E 2	QCY07	A 5		
CCY32	B 10	QCY09	B 11		
CCY35	G 7	QCY10	B 12		
CCY36	G 8	QCY12	B 12		
CCY38	A 7	QCY13	F 2		
CCY39	A 4	QCY14	C 12		
CCY41	A 7	QCY15	D 12		
CCY42	B 5	QCY16	E 12		
CCY43	B 7	QCY18	C 12		
CCY45	A 6	QCY19	F 11		
CCY46	B 3	QY04	A 10		
CCY47	A 9	QY06	A 8		
CCY48	B 3	RCJ19	F 14		
CCY50	G 6	RCL12	K 12		
CCY52	G 9	RCL30	I 12		
CCY55	D 3	RCL31	G 13		
CCY84	E 11	RCL32	F 13		
CCY91	H 7	RCL33	F 12		
CCY92	B 3	RCL34	F 13		
CCY93	B 5	RCL36	G 12		
CCY94	F 12	RCY02	B 3		
CCY98	F 10	RCY03	F 12		
CCY99	C 11	RCY04	G 6		
CL07	K 11	RCY05	G 12		
CL13	K 10	RCY07	K 4		
CL21	I 12	RCY08	J 6		
CL22	I 11	RCY09	A 7		
CL23	K 12	RCY13	A 10		
CL26	K 10	RCY15	C 10		
CL27	K 12	RCY16	G 7		
CN51	F 10	RCY17	B 7		
CY10	A 10	RCY18	C 11		
CY12	G 5	RCY23	B 9		
CY13	I 6	RCY25	A 4		
CY18	G 6	RCY26	B 10		
CY40	B 9	RCY32	B 11		
CY49	A 11	RCY34	D 11		
CY53	B 9	RCY35	D 11		
CY56	A 9	RCY37	C 10		
CY57	C 3	RCY38	C 10		
CY58	D 3	RCY39	B 2		
CY59	B 6	RCY41	D 10		
CY60	F 3	RCY43	B 10		
CY62	G 4	RCY45	A 5		
CY63	C 10	RCY48	G 4		
CY64	G 4	RCY50	A 7		
CY65	G 6	RCY51	B 7		
CY66	G 6	RCY52	A 4		
CY67	G 7	RCY53	B 2		
CY68	D 10	RCY55	B 11		
CY69	B 6	RCY56	B 10		
CY70	C 2	RCY57	B 11		
CY71	C 3	RCY59	A 10		
CY73	A 8	RCY60	F 2		
CY74	A 8	RCY61	F 2		
CY75	F 3	RCY66	E 10		
CY76	E 3	RCY70	C 12		
CY77	A 8	RCY71	C 12		
CY78	B 4	RCY72	C 12		
CY79	D 10	RCY74	E 12		
CY80	I 5	RCY75	E 12		



# Bedienplatte / Keyboard Control Unit (TM)

Ansicht von der Lötseite / View of Solder Side

CF01 3 B	CF05 9 B	DF03 2 A	DF07 7 B	DF11 7 B	J003 10 A	J007 7 B	JP01 6 A	PF01 1 B	QF02 6 B	RF02 6 B	RF06 4 B	RF10 10 A	RF14 8 A	RF19 4 B
CF02 4 B	CF06 10 B	DF04 4 B	DF08 13 B	IF01 2 B	J004 4 A	J008 2 B	JP02 4 A	PF02 15 B	QF03 3 B	RF03 6 B	RF07 4 B	RF11 12 A	RF15 9 A	RF20 12 B
CF03 8 B	DF01 2 B	DF05 12 B	DF09 7 A	J001 7 B	J005 5 A	J009 3 B	LF01 8 B	PF04 1 B	QF04 5 B	RF04 6 B	RF08 5 B	RF12 13 A	RF16 9 A	RF21 12 B
CF04 9 B	DF02 2 A	DF06 3 B	DF10 7 B	J002 7 B	J006 8 B	J010 6 A	LF02 10 B	QF01 6 B	RF01 5 B	RF05 4 B	RF09 11 A	RF13 13 A	RF17 10 A	RF22 9 B
														RF23 9 B
														RF25 7 B
														RF26 2 B
														SW03 11 A
														SW04 11 A
														SW05 12 A
														SW06 13 A
														SW07 2 A
														SW08 8 A
														SW09 8 A
														SW10 9 A
														SW11 10 A
														SW12 7 A
														SW13 14 B

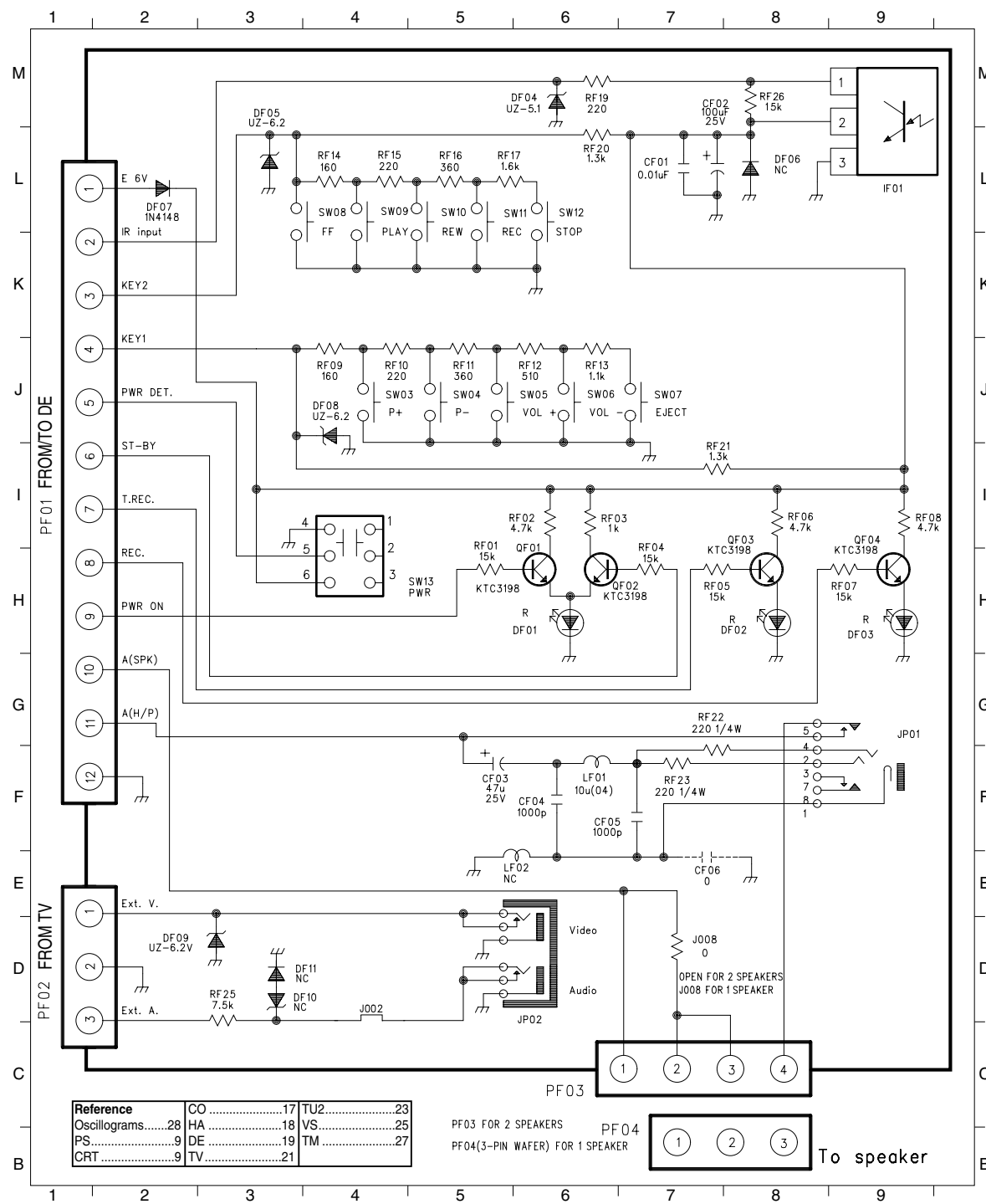
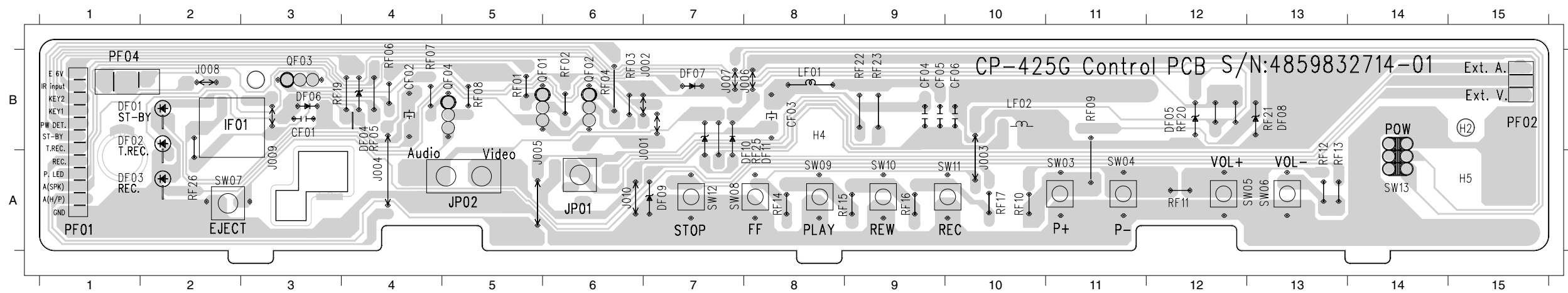

CF01	L7
CF02	L8
CF03	G6
CF04	F6
CF05	F7
CF06	F7
DF01	H6
DF02	H8
DF03	H9
DF04	M6
DF05	L3
DF06	L8
DF07	L2
DF08	J4
DF09	D3
DF10	D3
DF11	D3
IF01	M9
J008	D7
JP01	G9
JP02	C6
LF01	G6
LF02	F6
PF01	J2
PF02	D2
PF03	B7
PF04	B8
QF01	H6
QF02	H7
QF03	H8
QF04	H9
RF01	H5
RF02	I6
RF03	I6
RF04	H7
RF05	H8
RF06	I8
RF07	H9
RF08	I9
RF09	J4
RF10	J5
RF11	J5
RF12	J6
RF13	J6
RF14	L4
RF15	L4
RF16	L5
RF17	L6
RF19	M6
RF20	M6
RF21	J8
RF22	G8
RF23	G7
RF25	C3
RF26	M8
SW03	J4
SW04	J5
SW05	J5
SW06	J6
SW07	J7
SW08	L4
SW09	L4
SW10	L5
SW11	L5
SW12	L6
SW13	H4

## Oszillogramme / Oscillograms

Hinweis: Alle Oszillogramme sind an einem TVR 3740/1 TOP gemessen  
 Note: All oscillograms are measured with a TVR 3740/1 TOP

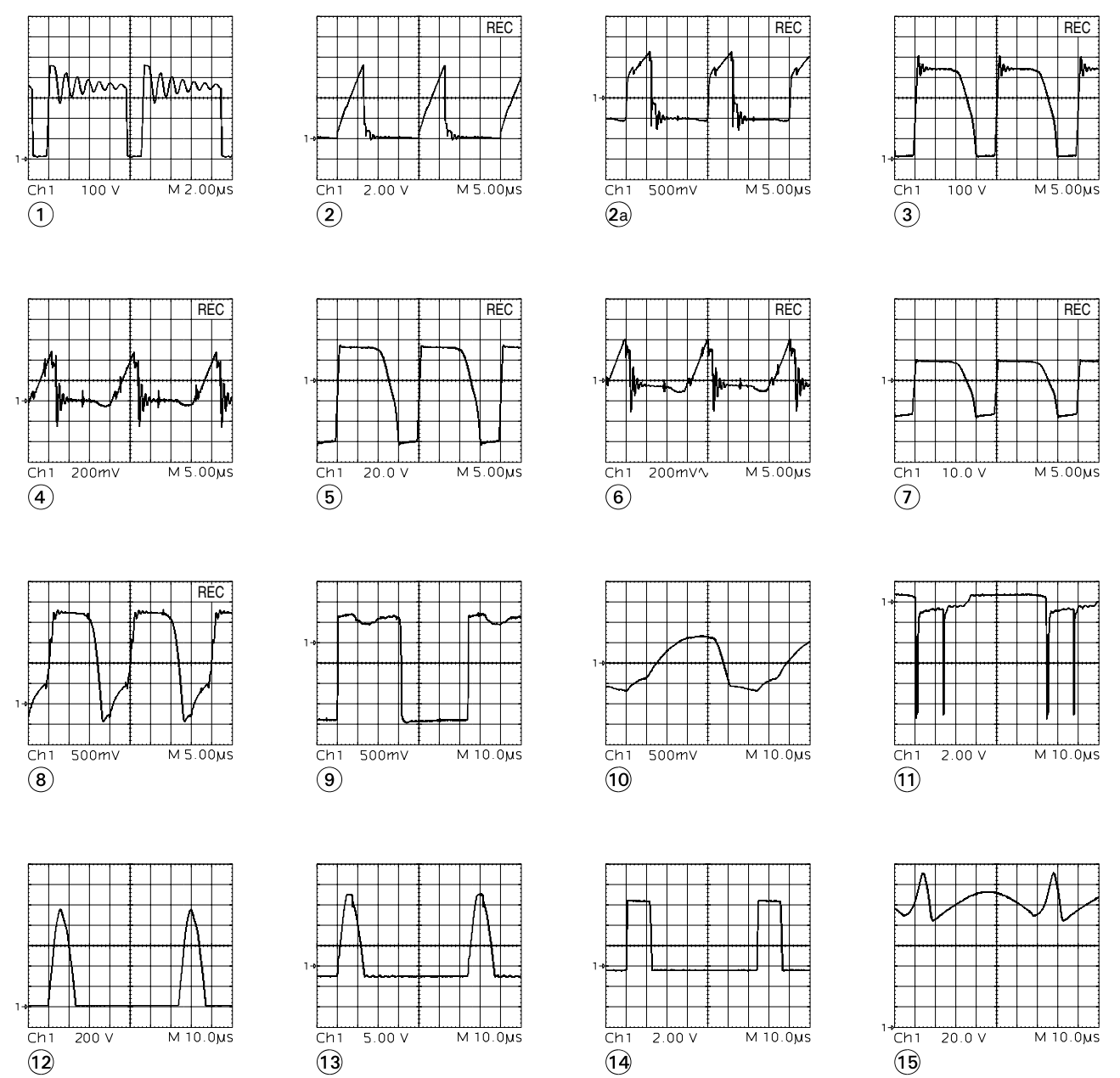

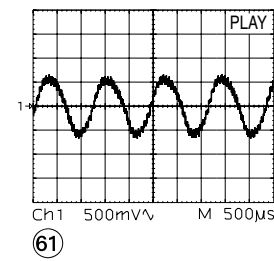
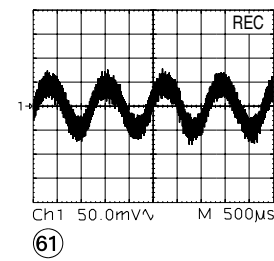
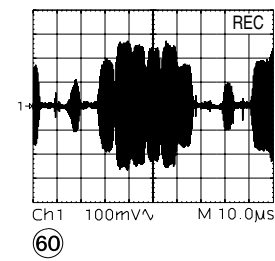
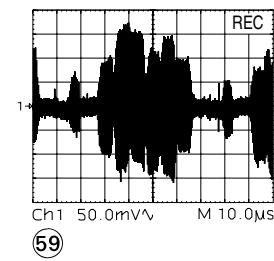
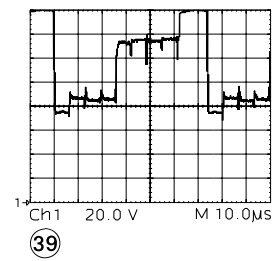
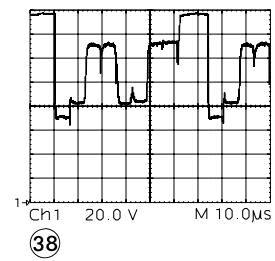
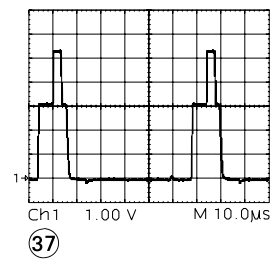
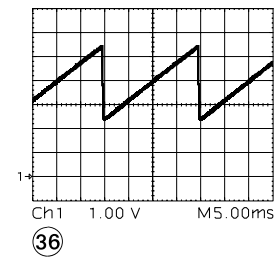
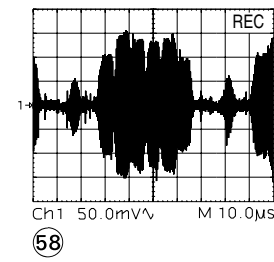
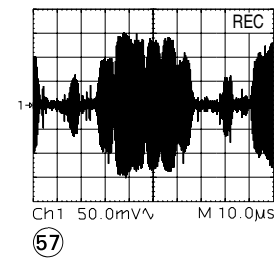
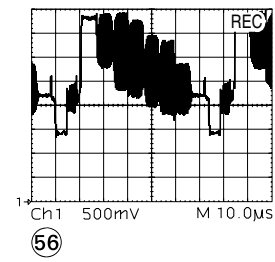
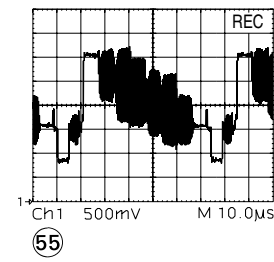
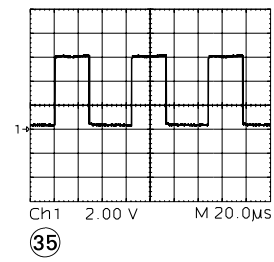
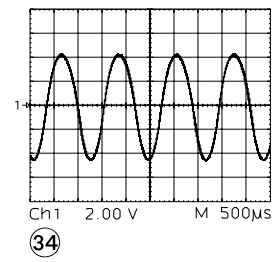
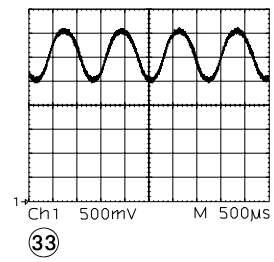
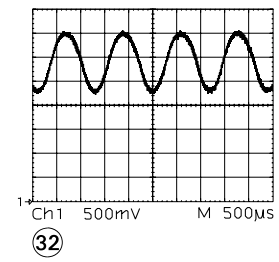
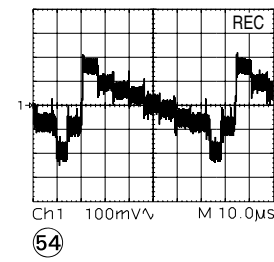
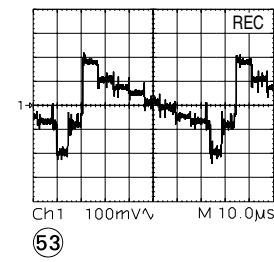
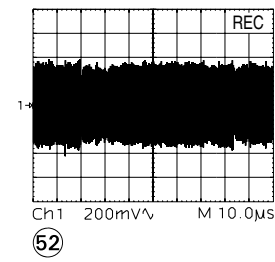
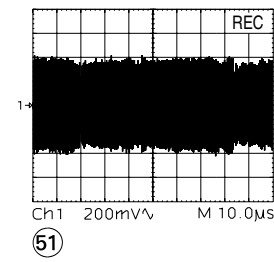
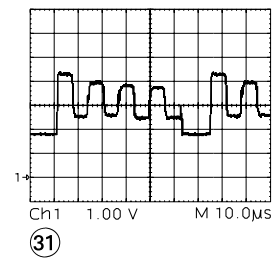
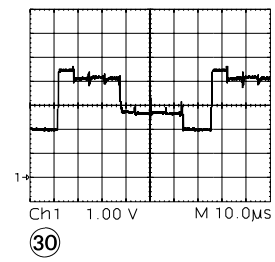
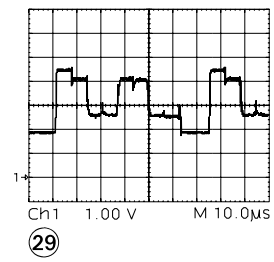
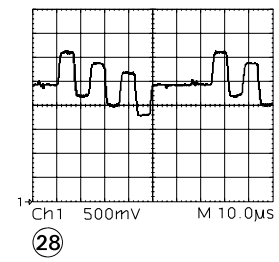
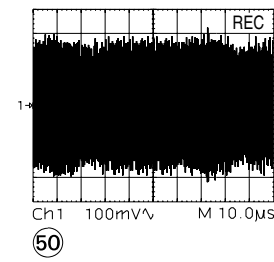
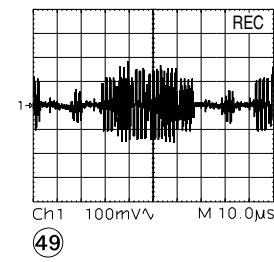
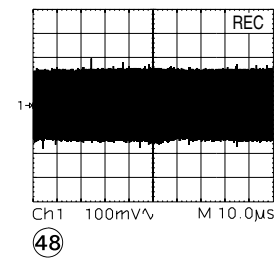
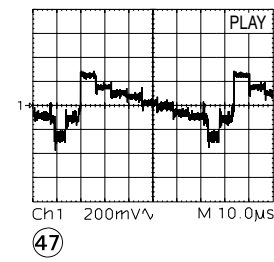
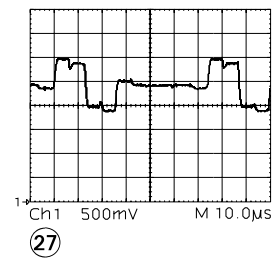
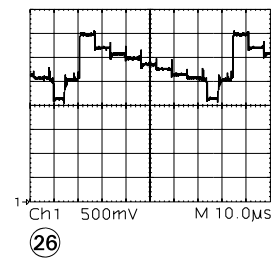
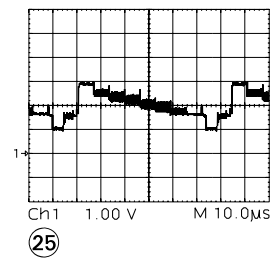
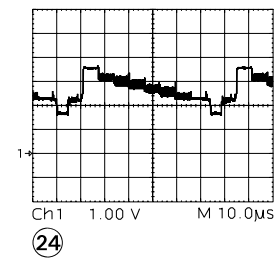
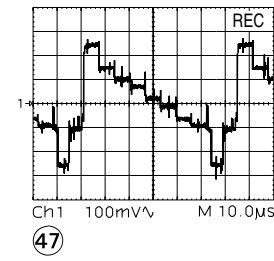
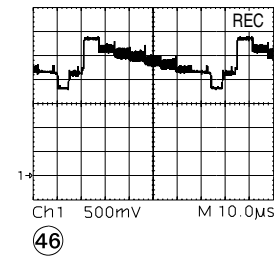
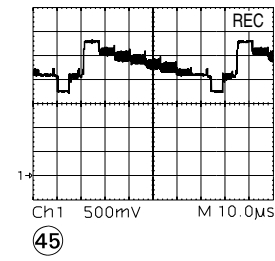
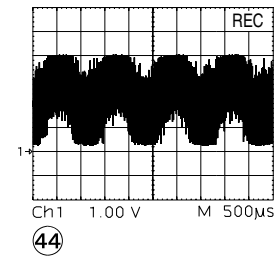
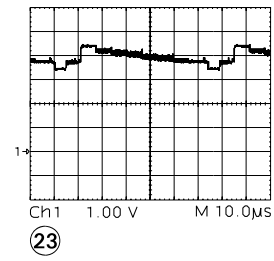
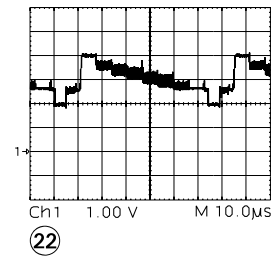
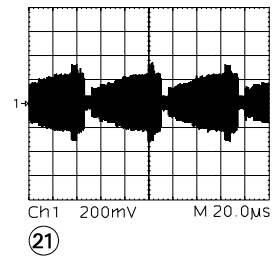
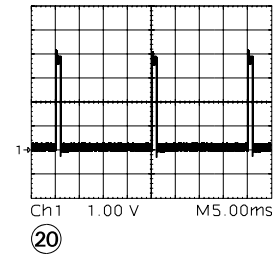
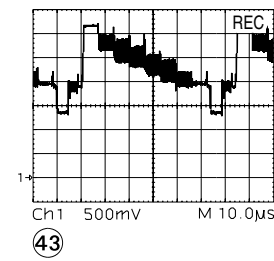
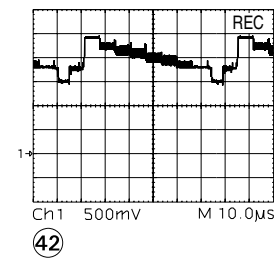
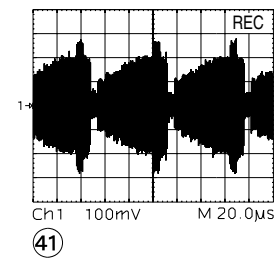
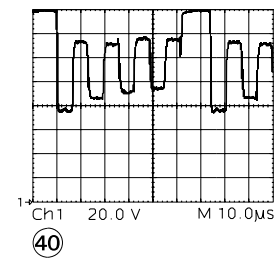
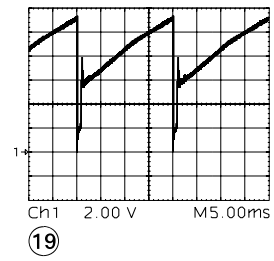
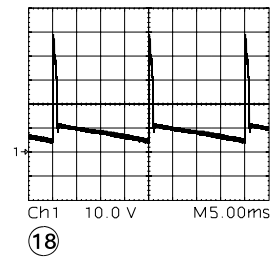
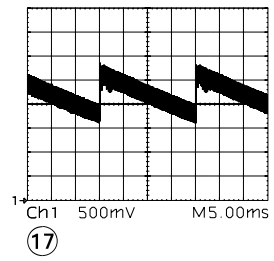
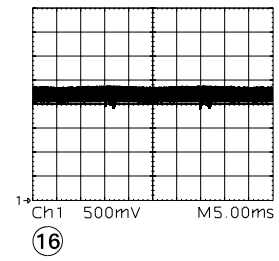

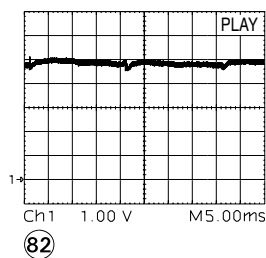
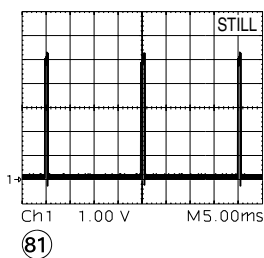
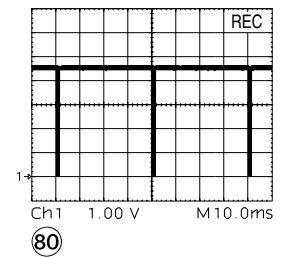
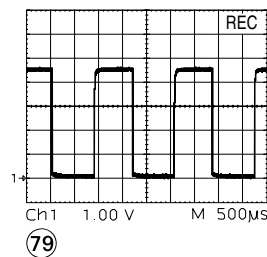
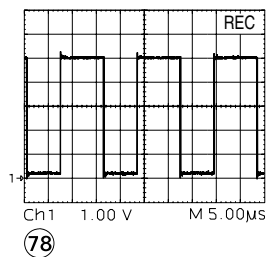
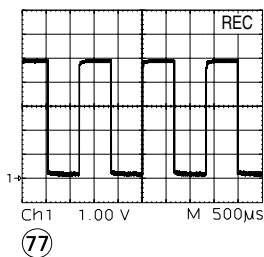
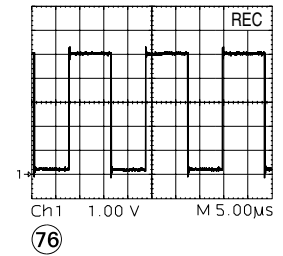
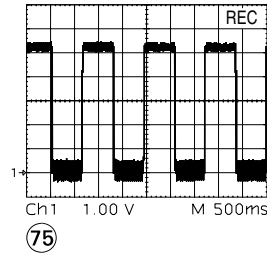
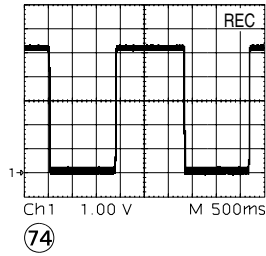
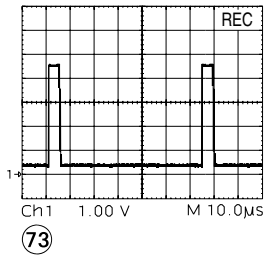
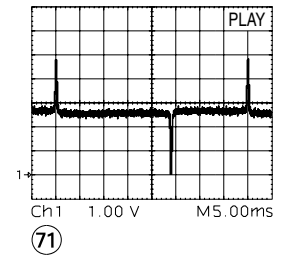
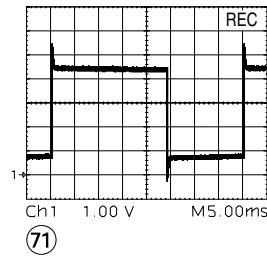
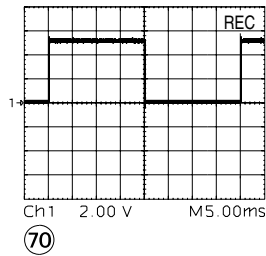
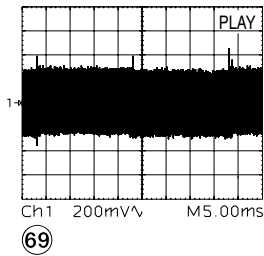
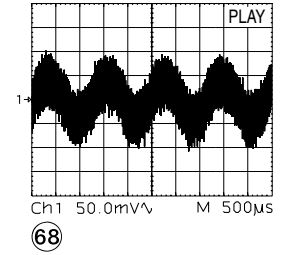
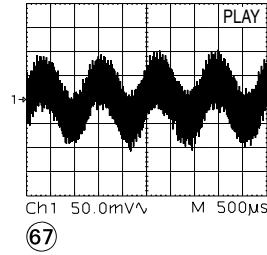
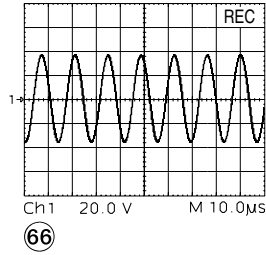
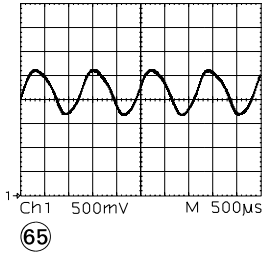
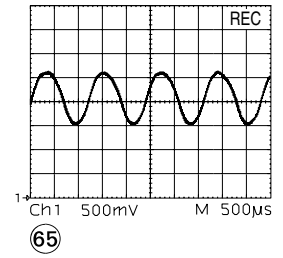
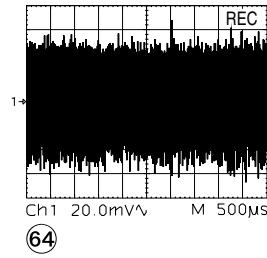
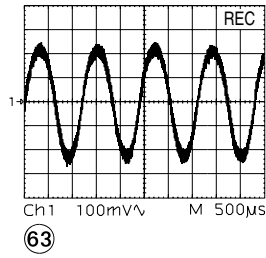
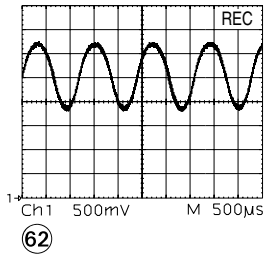

Blockschaltplan – Netzteil/Digital / Block Circuit Diagram – Power Supply/Digital

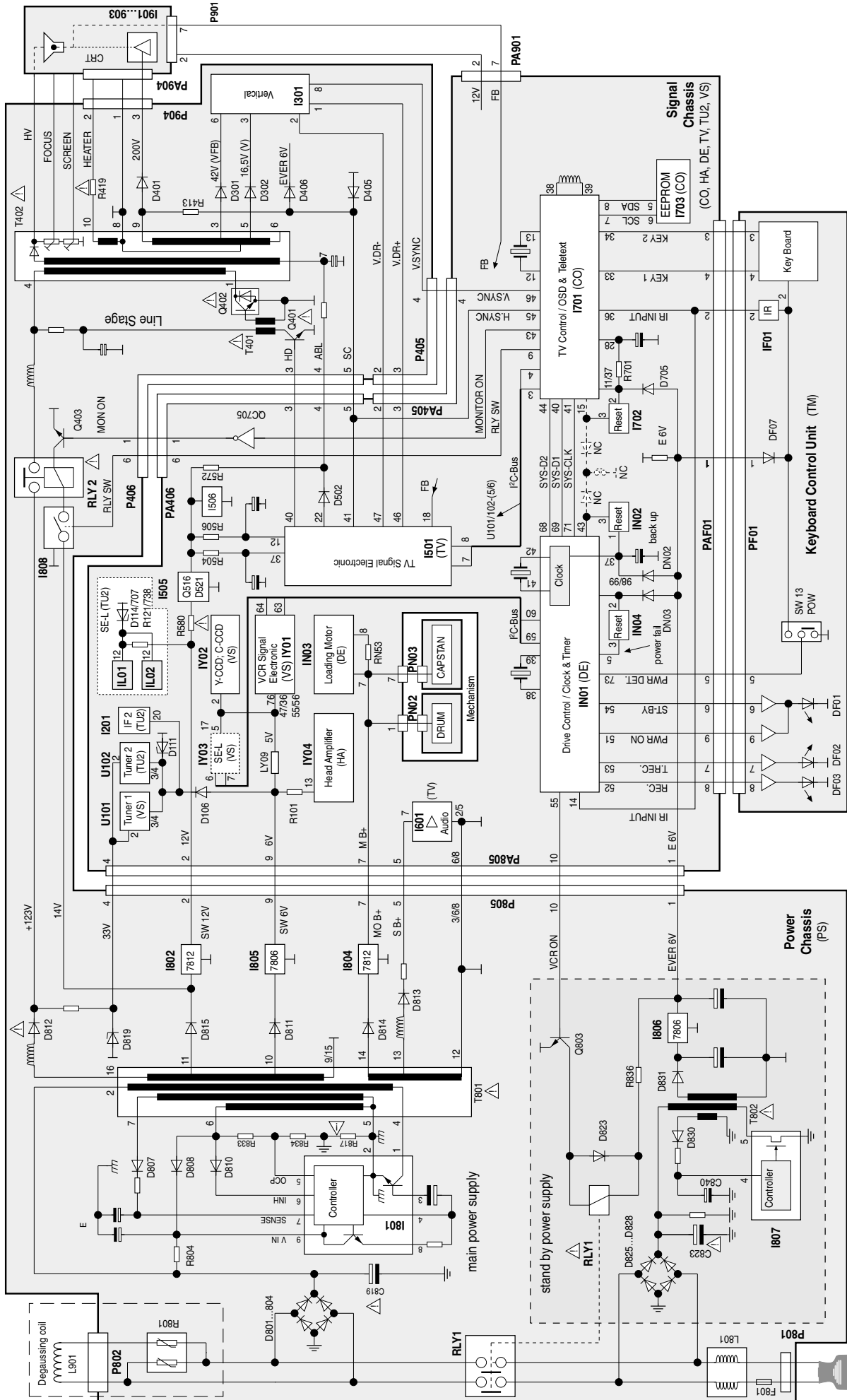

Reference	CO	HA	DE	TV	TU2	VS	TM
Oscillograms...	4-22	4-12	4-13	4-15	4-11	4-12	4-19
PS	4-5	4-5	4-13	4-15	4-11	4-12	4-21
CRT	4-7	4-7	4-15	4-15	4-11	4-12	4-21

# Blockschaltplan / Block Circuit Diagram – TV/VCR

Reference	CO ..... 4-11	TU2 ..... 4-17
Oscillograms	HA ..... 4-12	VS ..... 4-19
PS ..... 4-5	DE ..... 4-13	TM ..... 4-21
CRT ..... 4-7	TV ..... 4-15	

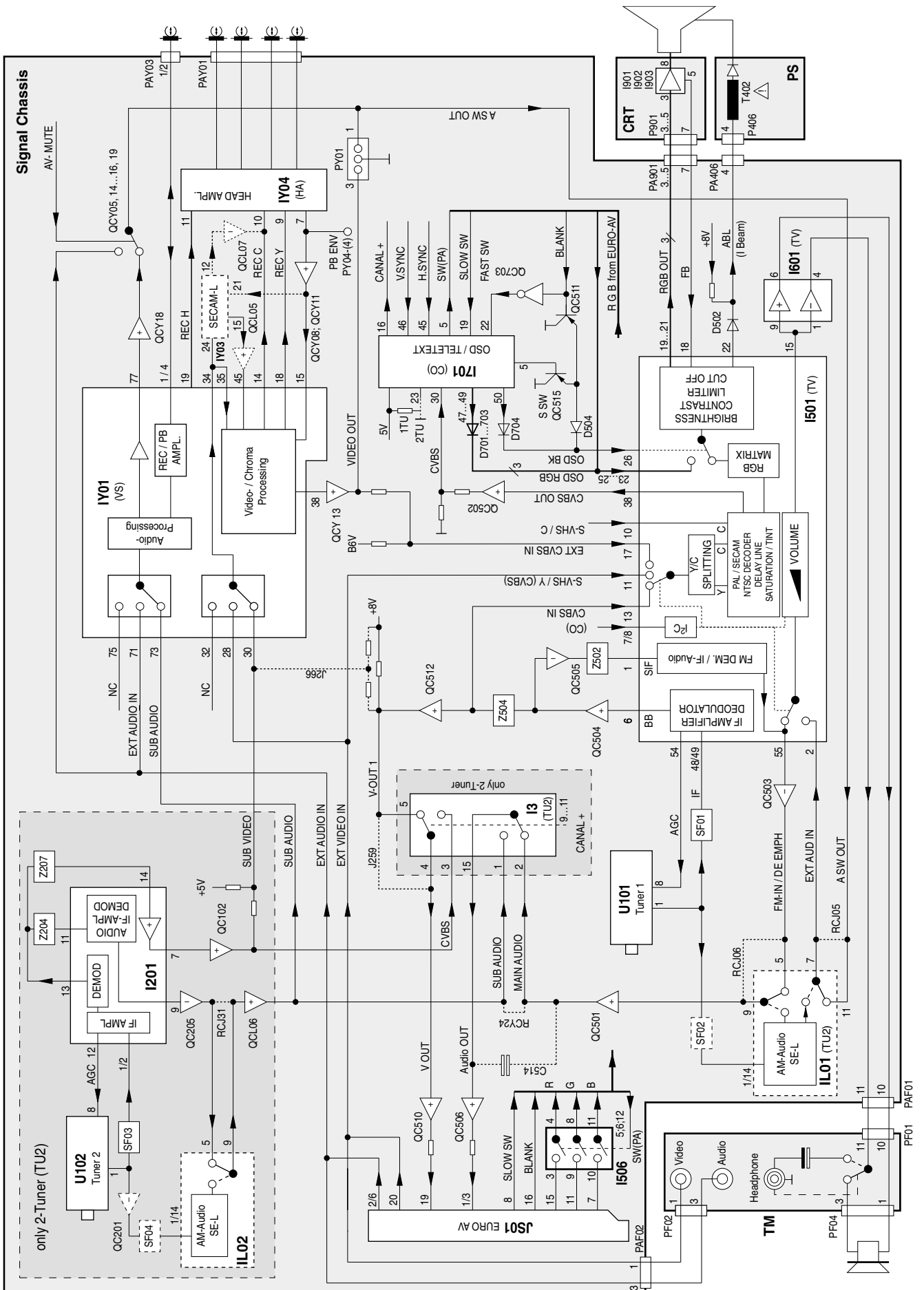

# Explosionszeichnung und Ersatzteillisten Exploded View and Spare Parts Lists

**3**

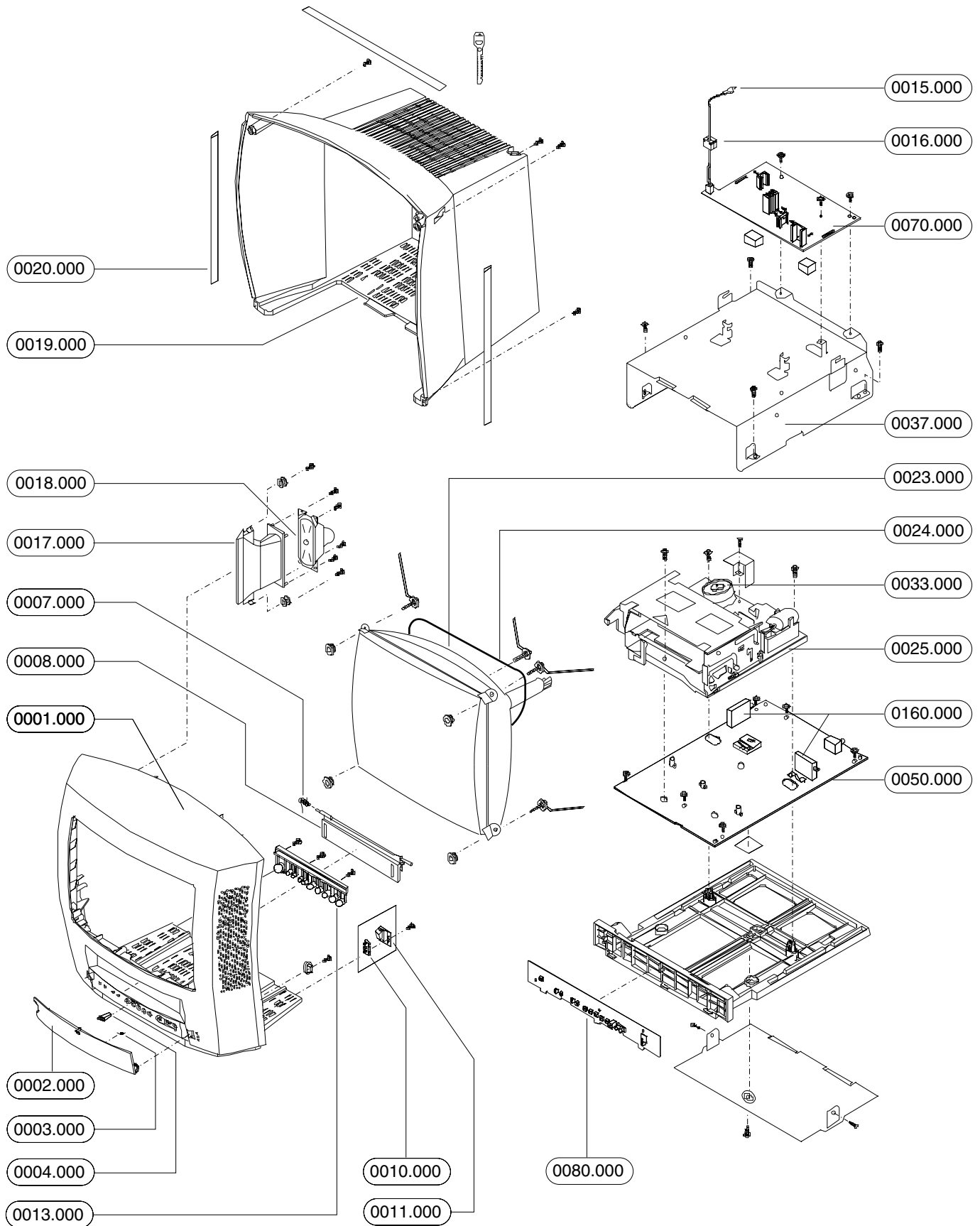

Ersatzteilliste  
Pièces détachées

9 / 99

GRUNDIG

TVR

TVR 3735 FR/TOP

MATERIAL-NR. / N<sup>o</sup> REFERENCE.: 77250 121 7200  
BESTELL-NR. / NO. COMMANDE.: G.CI 28-72 FB

POS. NR. N <sup>o</sup> POS.	ABB. FIG.	MATERIAL-NR. REFERENCE	ANZ. NB	BEZEICHNUNG (D)	DESIGNATION (F)
		77250 121 7200		TVR 3735 FR/TOP KEIN E-TEIL	TVR 3735 FR/TOP VOIR LISTE SEPARÉE
0001.000	3	75988 051 0000		GEH.-VORDERTEIL	EBENISTERIE AVANT CPL
0002.000	3	75988 051 0200		KLAPPE GEH.-VORDERTEIL	VOLET EBENISTERIE AVANT
0003.000	3	75988 051 0400		FEDER	RESSORT
0004.000	3	75988 051 0800		VERRIEGELUNG	VERROUILLAGE
0007.000	3	75988 052 2800		FEDER	RESSORT
0008.000	3	75988 052 1600		CASSETTENFACHKLAPPE	VOLET DE CASSETTE CPL
0010.000	3	75988 051 0700		FENSTER LED	WINDOW LED
0011.000	3	75988 051 0600		KNOPF EJECT	BOUTON EJECT
0013.000	3	75988 051 0500		TASTENSATZ	JEU DE TOUCHES
0014.000		75988 053 6700		ANTENNE	ANTENNE
0015.000	△	75988 053 2000		NETZKABEL	CABLE SECTEUR
0016.000	3	75988 053 3300		HALTER NETZKABEL	SUPPORT CABLE SECTEUR
0017.000	3	75988 053 3100		GEH. LAUTSPRECHER	BOITIER HAUT PARLEUR
0018.000	3	75988 051 1000		LAUTSPRECHER	HAUT PARLEUR
0019.000	3	75988 053 3200		GEH.-RUECKTEIL	BOITIER ARRIERE CPL
0020.000	3	75988 053 3400		FILZ SCHWARZ	FEUTRE NOIR
0021.000		29642 061 1300		FERNBEDIENUNG TP 870	TELECOMMANDE TP 870
0023.000	△	75988 051 0900		BILDROEHRE 434JLL90X	TUBE IMAGE 434JLL90X
0024.000	△	75988 051 0100		ENTMAGNETISIERUNGSSPULE 14"	BOBINE DE DEMATNETISATION 14"
0025.000	△	75988 052 0000	X	LAUFWERK KEIN E-TEIL	PLATINE MECANIQUE VOIR LISTE SEPARÉE
0033.000	3	27599 005 3500		KOPFRAD 2/0 SP/LP KPL.	TAMBOUR DE TETES 2/0 SP/LP CPL
0050.000	△	27599 101 8500	X	SIGNALCHASSIS KEIN E-TEIL	C.I. TRAITEMENT DU SIGNAL VOIR LISTE SEPARÉE
0070.000	△	27599 103 3000	X	LEISTUNGSSCHASSIS + BILDROHRPL. KEIN E-TEIL	C.I. ALIMENTATION + C.I. TUBE VOIR LISTE SEPARÉE
0080.000	△	27599 002 8300	X	LP-BEDIENMODUL	C.I. COMMANDE
0160.000	3	75988 053 0200		TUNER DT5-BF15P	TUNER DT5-BF15P
		72010 536 9000		BEDIENUNGSANLEITUNG F	MODE D'EMPLOI F
		72010 536 6000		SERVICE MANUAL D/GB	INSTRUCTION DE SERVICE D/GB
		72010 536 6100		SERVICE MANUAL ERG. D/GB	INSTRUCTION DE SERVICE D/GB SUPPL.

X = SIEHE GESONDERTE E-LISTE

X = VOIR LISTE DE PIECES A PART

Es gelten die Vorschriften und Sicherheitshinweise gemäß dem Service Manual "Sicherheit", Mat.-Nummer 72010 800 0000, sowie zusätzlich die eventuell abweichenden, landesspezifischen Vorschriften!



Il y a lieu d'observer les recommandations et les prescriptions de sécurité de l'Instruction de Service "Sécurité" Réf. N<sup>o</sup> 72010 800 0000 ainsi que les prescriptions spécifiques à chaque pays!

ÄNDERUNGEN VORBEHALTEN / SOUS RESERVE DE MODIFICATIONS

Ersatzteilliste  
Spare Parts List

10 / 99

GRUNDIG

TVR

TVR 3735/1 TOP  
TVR 3735/2 TOP \*MATERIAL-NR. / PART NO.: 77250 115 7200 BESTELL-NR. / ORDER NO.: G.CI 26-72  
MATERIAL-NR. / PART NO.: 77250 116 7200 BESTELL-NR. / ORDER NO.: G.CI 27-72 \*

POS. NR. POS. NO.	ABB. FIG.	MATERIAL-NR. PART NUMBER	ANZ. QTY.	BEZEICHNUNG (D)	DESCRIPTION (GB)
		77250 115 7200		TVR 3735/1 TOP KEIN E-TEIL	TVR 3735/1 TOP NO SPARE PART
		77250 116 7200		TVR 3735/2 TOP KEIN E-TEIL	TVR 3735/2 TOP NO SPARE PART
0001.000	3	75988 051 0000		GEH.-VORDERTEIL	FRONT CASE
0002.000	3	75988 051 0200		KLAPPE GEH.-VORDERTEIL	FLAP FRONT PANEEL
0003.000	3	75988 051 0400		FEDER	SPRING
0004.000	3	75988 051 0800		VERRIEGELUNG	LOCK
0007.000	3	75988 052 2800		FEDER	SPRING
0008.000	3	75988 052 1600		CASSETTENFACHKLAPPE	LIFT FLAP
0010.000	3	75988 051 0700		FENSTER LED	WINDOW LED
0011.000	3	75988 051 0600		KNOPF EJECT	KNOB EJECT
0013.000	3	75988 051 0500		TASTENSATZ	PUSH BUTTON SET
0014.000		75988 058 6700		ANTENNE	ANTENNA
0015.000	△	75988 053 2000		NETZKABEL	POWER CORD
0016.000	3	75988 053 3300		HALTER NETZKABEL	HOLDER POWER CABLE
0017.000	3	75988 053 3100		GEH. LAUTSPRECHER	CASE LOUDSPEAKER
0018.000	3	75988 051 1000		LAUTSPRECHER	LOUDSPEAKER
0019.000	3	75988 053 3200		GEH.-RUECKTEIL	REAR CASE
0020.000	3	75988 053 3400	3	FILZ SCHWARZ	FELT BLACK
0021.000		29642 061 1300		FERNBEDIENUNG TP 870	REMOTE CONTROL TP 870
0023.000	△	75988 051 0900		BILDROEHRE 434JLL90X	CRT 434JLL90X
0024.000	△	75988 051 0100		ENTMAGNETISIERUNGSSPULE 14"	DEGAUSSING COIL 14"
0025.000	△	75988 052 0000	X	LAUFWERK KEIN E-TEIL	TAPE DRIVE NO SPARE PART
0033.000	3	27599 005 3400		KOPFRAD 2/0 SP KPL	HEAD WHEEL 2/0 SP ASSY
0050.000	△	27599 101 8100	X	SIGNALCHASSIS KEIN E-TEIL	SIGNALCHASSIS NO SPARE PART
0070.000	△	27599 103 3000	X	LEISTUNGSSCHASSIS + BILDROHRPL. KEIN E-TEIL	POWER CHASSIS + PICT. TUBE BOARD NO SPARE PART
0080.000	△	27599 002 8300	X	LP-BEDIENMODUL	LP-CONTROL BOARD
0160.000	3	75988 053 0200		TUNER DT5-BF15P	TUNER DT5-BF15P
		72010 536 5100		BEDIENUNGSANLEITUNG D/I	INSTRUCTION MANUAL D/I
		72010 536 5200		BEDIENUNGSANLEITUNG F/NL	INSTRUCTION MANUAL F/NL
		72010 536 5300		BEDIENUNGSANLEITUNG E/P	INSTRUCTION MANUAL E/P
		72010 537 5200	*	BEDIENUNGSANLEITUNG GB	INSTRUCTION MANUAL GB
		72010 537 5000	*	BEDIENUNGSANLEITUNG S/N	INSTRUCTION MANUAL S/N
		72010 537 5100		BEDIENUNGSANLEITUNG DK/FIN	INSTRUCTION MANUAL DK/FIN
		72010 536 6000		SERVICE MANUAL D/GB	SERVICE MANUAL D/GB
		72010 536 6100		SERVICE MANUAL ERG. D/GB	SERVICE MANUAL SUPPLEMENT D/GB

X = SIEHE GESONDERTE E-LISTE

X = SEE SEPARATE PARTS LIST

Es gelten die Vorschriften und Sicherheitshinweise gemäß dem Service Manual "Sicherheit", Mat.-Nummer 72010 800 0000, sowie zusätzlich die eventuell abweichenden, landesspezifischen Vorschriften!



The regulations and safety instructions shall be valid as provided by the "Safety" Service Manual, part number 72010 800 0000, as well as the respective national deviations.

ÄNDERUNGEN VORBEHALTEN / SUBJECT TO ALTERATION

Ersatzteilliste  
Pièces détachées

9 / 99

GRUNDIG

TVR

TVR 3740 FR/TOP

MATERIAL-NR. / N<sup>o</sup> REFERENCE.: 77250 122 7200  
BESTELL-NR. / NO. COMMANDE.: G.CI 30-72 FB

POS. NR. N <sup>o</sup> POS.	ABB. FIG.	MATERIAL-NR. REFERENCE	ANZ. NB	BEZEICHNUNG (D)	DESIGNATION (F)
		77250 122 7200		TVR 3740 FR/TOP KEIN E-TEIL	TVR 3740 FR/TOP VOIR LISTE SEPAREE
0001.000	3	75988 051 0000		GEH.-VORDERTEIL	EBENISTERIE AVANT CPL
0002.000	3	75988 051 0200		KLAPPE GEH.-VORDERTEIL	VOLET EBENISTERIE AVANT
0003.000	3	75988 051 0400		FEDER	RESSORT
0004.000	3	75988 051 0800		VERRIEGELUNG	VERROUILLAGE
0007.000	3	75988 052 2800		FEDER	RESSORT
0008.000	3	75988 052 1600		CASSETTENFACHKLAPPE	VOLET DE CASSETTE CPL
0010.000	3	75988 051 0700		FENSTER LED	WINDOW LED
0011.000	3	75988 051 0600		KNOPF EJECT	BOUTON EJECT
0013.000	3	75988 051 0500		TASTENSATZ	JEU DE TOUCHES
0014.000		75988 058 6700		ANTENNE	ANTENNE
0015.000	Δ	75988 053 2000		NETZKABEL	CABLE SECTEUR
0016.000	3	75988 053 3300		HALTER NETZKABEL	SUPPORT CABLE SECTEUR
0017.000	3	75988 053 3100		GEH. LAUTSPRECHER	BOUTIER HAUT PARLEUR
0018.000	3	75988 051 1000		LAUTSPRECHER	HAUT PARLEUR
0019.000	3	75988 053 3200		GEH.-RUECKTEIL	BOITIER ARRIERE CPL
0020.000	3	75988 053 3400		FILZ SCHWARZ	FEUTRE NOIR
0021.000		29642 061 1300		FERNBEDIENUNG TP 870	TELECOMMANDE TP 870
0023.000	Δ	75988 051 0900		BILDROEHRE 434JLL90X	TUBE IMAGE 434JLL90X
0024.000	Δ	75988 051 0100		ENTMAGNETISIERUNGSSPULE 14"	BOBINE DE DEMATNETISATION 14"
0025.000	Δ	75988 052 0000	X	LAUFWERK KEIN E-TEIL	PLATINE MECANIQUE VOIR LISTE SEPAREE
0033.000	3	27599 005 3500		KOPFRAD 2/0 SP/LP KPL.	TAMBOUR DE TETES 2/0 SP/LP CPL
0050.000	Δ	27599 101 8200	X	SIGNALCHASSIS KEIN E-TEIL	C.I. TRAITEMENT DU SIGNAL VOIR LISTE SEPAREE
0070.000	Δ	27599 103 3000	X	LEISTUNGSSCHASSIS + BILDROHRPL. KEIN E-TEIL	C.I. ALIMENTATION + C.I. TUBE VOIR LISTE SEPAREE
0080.000	Δ	27599 002 8300	X	LP-BEDIENMODUL	C.I. COMMANDE
0160.000	3	75988 053 0200	2	TUNER DT5-BF15P	TUNER DT5-BF15P
		72010 536 9500		BEDIENUNGSANLEITUNG F	MODE D'EMPLOI F
		72010 536 6000		SERVICE MANUAL D/GB	INSTRUCTION DE SERVICE D/GB
		72010 536 6100		SERVICE MANUAL ERG. D/GB	INSTRUCTION DE SERVICE D/GB SUPPL.

X = SIEHE GESONDERTE E-LISTE

X = VOIR LISTE DE PIECES A PART

Es gelten die Vorschriften und Sicherheitshinweise gemäß dem Service Manual "Sicherheit", Mat.-Nummer 72010 800 0000, sowie zusätzlich die eventuell abweichenden, landesspezifischen Vorschriften!



Il y a lieu d'observer les recommandations et les prescriptions de sécurité de l'Instruction de Service "Sécurité" Réf. N<sup>o</sup> 72010 800 0000 ainsi que les prescriptions spécifiques à chaque pays!

ÄNDERUNGEN VORBEHALTEN / SOUS RESERVE DE MODIFICATIONS

Ersatzteilliste  
Spare Parts List

10 / 99

GRUNDIG

TVR

TVR 3740 FT/GB

MATERIAL-NR. / PART NO.: 77250 119 7200  
BESTELL-NR. / ORDER NO.: G.CI 31-72 GB

POS. NR. POS. NO.	ABB. FIG.	MATERIAL-NR. PART NUMBER	ANZ. QTY.	BEZEICHNUNG (D)	DESCRIPTION (GB)
		77250 119 7200		TVR 3740 FT/GB KEIN E-TEIL	TVR 3740 FT/GB NO SPARE PART
0001.000	3	75988 051 0000		GEH.-VORDERTEIL	FRONT CASE
0002.000	3	75988 051 0200		KLAPPE GEH.-VORDERTEIL	FLAP FRONT PANEL
0003.000	3	75988 051 0400		FEDER	SPRING
0004.000	3	75988 051 0800		VERRIEGELUNG	LOCK
0007.000	3	75988 052 2800		FEDER	SPRING
0008.000	3	75988 052 1600		CASSETTENFACHKLAPPE	LIFT FLAP ASSY
0010.000	3	75988 051 0700		FENSTER LED	WINDOW LED
0011.000	3	75988 051 0600		KNOPF EJECT	KNOB EJECT
0013.000	3	75988 051 0500		TASTENSATZ	PUSH BUTTON SET
0014.000		75988 058 6800		ANTENNE	ANTENNA
0015.000	Δ	75988 053 4600		NETZKABEL	POWER CORD
0016.000	3	75988 053 3300		HALTER NETZKABEL	HOLDER POWER CABLE
0017.000	3	75988 053 3100		GEH. LAUTSPRECHER	CASE LOUDSPEAKER
0018.000	3	75988 051 1000		LAUTSPRECHER	LOUDSPEAKER
0019.000	3	75988 053 3200		GEH.-RUECKTEIL	REAR CASE
0020.000	3	75988 053 3400	3	FILZ SCHWARZ	FELT BLACK
0021.000		29642 061 1300		FERNBEDIENUNG TP 870	REMOTE CONTROL TP 870
0023.000	Δ	75988 051 0900		BILDROEHRE 434JLL90X	CRT 434JLL90X
0024.000	Δ	75988 051 0100		ENTMAGNETISIERUNGSSPULE 14"	DEGAUSING COIL 14"
0025.000	Δ	75988 052 0000	X	LAUFWERK KEIN E-TEIL	TAPE DRIVE NO SPARE PART
0033.000	3	27599 005 3400		KOPFRAD 2/0 SP KPL	HEAD WHEEL 2/0 SP ASSY
0050.000	Δ	27599 101 8300	X	SIGNALCHASSIS KEIN E-TEIL	SIGNALCHASSIS NO SPARE PART
0070.000	Δ	27599 103 3000	X	LEISTUNGSSCHASSIS + BILDROHRPL. KEIN E-TEIL	POWER CHASSIS + PICT. TUBE BOARD NO SPARE PART
0080.000	Δ	27599 002 8300	X	LP-BEDIENMODUL	LP-CONTROL BOARD
0160.000	3	75988 053 0200	2	TUNER DT5-BF15P	TUNER DT5-BF15P
		72010 537 0500		BEDIENUNGSANLEITUNG GB	INSTRUCTION MANUAL GB
		72010 536 6000		SERVICE MANUAL D/GB	SERVICE MANUAL D/GB
		72010 536 6100		SERVICE MANUAL ERG. D/GB	SERVICE MANUAL SUPPLEMENT D/GB

X = SIEHE GESONDERTE E-LISTE

X = SEE SEPARATE PARTS LIST

Es gelten die Vorschriften und Sicherheitshinweise gemäß dem Service Manual "Sicherheit", Mat.-Nummer 72010 800 0000, sowie zusätzlich die eventuell abweichenden, landesspezifischen Vorschriften!



The regulations and safety instructions shall be valid as provided by the "Safety" Service Manual, part number 72010 800 0000, as well as the respective national deviations.

ÄNDERUNGEN VORBEHALTEN / SUBJECT TO ALTERATION



Ersatzteilliste  
Spare Parts List

10 / 99

GRUNDIG

TVR

TVR 3740/1 TOP  
TVR 3740/2 TOP \*MATERIAL-NR. / PART NO.: 77250 117 7200 BESTELL-NR. / ORDER NO.: G.CI 41-72  
MATERIAL-NR. / PART NO.: 77250 118 7200 BESTELL-NR. / ORDER NO.: G.CI 49-72 \*

POS. NR. POS. NO.	ABB. FIG.	MATERIAL-NR. PART NUMBER	ANZ. QTY.	BEZEICHNUNG (D)	DESCRIPTION (GB)
		77250 117 7200		TVR 3740/1 TOP KEIN E-TEIL	TVR 3740/1 TOP NO SPARE PART
		77250 118 7200		TVR 3740/2 TOP KEIN E-TEIL	TVR 3740/2 TOP NO SPARE PART
0001.000	3	75988 051 0000		GEH.-VORDERTEIL	FRONT CASE
0002.000	3	75988 051 0200		KLAPPE GEH.-VORDERTEIL	FLAP FRONT PANEEL
0003.000	3	75988 051 0400		FEDER	SPRING
0004.000	3	75988 051 0800		VERRIEGELUNG	LOCK
0007.000	3	75988 052 2800		FEDER	SPRING
0008.000	3	75988 052 1600		CASSETTENFACHKLAPPE	LIFT FLAP ASSY
0010.000	3	75988 051 0700		FENSTER LED	WINDOW LED
0011.000	3	75988 051 0600		KNOPF EJECT	KNOPF EJECT
0013.000	3	75988 051 0500		TASTENSATZ	PUSH BUTTON SET
0014.000		75988 058 6700		ANTENNE	ANTENNA
0015.000	△	75988 053 2000		NETZKABEL	POWER CORD
0016.000	3	75988 053 3300		HALTER NETZKABEL	HOLDER POWER CABLE
0017.000	3	75988 053 3100		GEH. LAUTSPRECHER	CASE LOUDSPEAKER
0018.000	3	75988 051 1000		LAUTSPRECHER	LOUDSPEAKER
0019.000	3	75988 053 3200		GEH.-RUECKTEIL	REAR CASE
0020.000	3	75988 053 3400	3	FILZ SCHWARZ	FELT BLACK
0021.000		29642 061 1300		FERNBEDIENUNG TP 870	REMOTE CONTROL TP 870
0023.000	△	75988 051 0900		BILDROEHRE 434JLL90X	CRT 434JLL90X
0024.000	△	75988 051 0100		ENTMAGNETISIERUNGSSPULE 14"	DEGAUSSING COIL 14"
0025.000	△	75988 052 0000	X	LAUFWERK KEIN E-TEIL	TAPE DRIVE NO SPARE PART
0033.000	3	27599 005 3400		KOPFRAD 2/0 SP KPL	HEAD WHEEL 2/0 SP ASSY
0050.000	△	27599 101 8000	X	SIGNALCHASSIS KEIN E-TEIL	SIGNALCHASSIS NO SPARE PART
0070.000	△	27599 103 3000	X	LEISTUNGSSCHASSIS + BILDROHRPL. KEIN E-TEIL	POWER CHASSIS + PICT. TUBE BOARD NO SPARE PART
0080.000	△	27599 002 8300	X	LP-BEDIENMODUL	LP-CONTROL BOARD
0160.000	3	75988 053 0200	2	TUNER DT5-BF15P	TUNER DT5-BF15P
		72010 536 5600		BEDIENUNGSANLEITUNG D/I	INSTRUCTION MANUAL D/I
		72010 536 5700		BEDIENUNGSANLEITUNG F/NL	INSTRUCTION MANUAL F/NL
		72010 536 5800		BEDIENUNGSANLEITUNG E/P	INSTRUCTION MANUAL E/P
		72010 537 4700	*	BEDIENUNGSANLEITUNG GB	INSTRUCTION MANUAL GB
		72010 537 4500	*	BEDIENUNGSANLEITUNG S/N	INSTRUCTION MANUAL S/N
		72010 537 4600	*	BEDIENUNGSANLEITUNG DK/FIN	INSTRUCTION MANUAL DK/FIN
		72010 536 6000		SERVICE MANUAL D/GB	SERVICE MANUAL D/GB
		72010 536 6100		SERVICE MANUAL ERG. D/GB	SERVICE MANUAL SUPP. D/GB

X = SIEHE GESONDERTE E-LISTE

X = SEE SEPARATE PARTS LIST

Es gelten die Vorschriften und Sicherheitshinweise gemäß dem Service Manual "Sicherheit", Mat.-Nummer 72010 800 0000, sowie zusätzlich die eventuell abweichenden, landesspezifischen Vorschriften!



The regulations and safety instructions shall be valid as provided by the "Safety" Service Manual, part number 72010 800 0000, as well as the respective national deviations.

ÄNDERUNGEN VORBEHALTEN / SUBJECT TO ALTERATION

GRUNDIG

TVR

TVR 5540 FR/TOP

MATERIAL-NR. / N° REFERENCE.: 77250 103 7200  
BESTELL-NR. / NO. COMMANDE.: G.CI 35-72 FBErsatzteilliste  
Pièces détachées

10 / 99

POS. NR. N° POS.	ABB. FIG.	MATERIAL-NR. REFERENCE	ANZ. NB	BEZEICHNUNG (D)	DESIGNATION (F)
		77250 121 7200		TVR 5540 FR/TOP KEIN E-TEIL	TVR 5540 FR/TOP VOIR LISTE SEPARÉE
0001.000	3	75988 053 5500		GEH.-VORDERTEIL	EBENISTERIE AVANT CPL
0002.000	3	75988 053 5700		KLAPPE GEH.-VORDERTEIL	VOLET EBENISTERIE AVANT
0003.000	3	75988 053 5800		FEDER KLAPPE	RESSORT
0004.000	3	75988 051 0800		VERRIEGELUNG	VERROUILLAGE
0007.000	3	75988 052 2800		FEDER	RESSORT
0008.000	3	75988 053 6400		CASSETTENFACHKLAPPE	VOLET DE CASSETTE CPL
0010.000	3	75988 053 6100		FENSTER LED	WINDOW LED
0011.000	3	75988 053 6000		KNOPF EJECT	BOUTON EJECT
0013.000	3	75988 053 5900		TASTENSATZ	JEU DE TOUCHES
0014.000		75988 058 6700		ANTENNE	ANTENNE
0015.000	△	75988 053 2000		NETZKABEL	CABLE SECTEUR
0016.000	3	75988 053 3300		HALTER NETZKABEL	SUPPORT CABLE SECTEUR
0017.000	3	75988 053 3100		GEH. LAUTSPRECHER	BOUTIER HAUT PARLEUR
0018.000	3	75988 051 1000		LAUTSPRECHER	HAUT PARLEUR
0019.000	3	75988 053 5600		GEH.-RUECKTEIL	BOITIER ARRIERE CPL
0020.000	3	75988 053 3400	3	FILZ SCHWARZ	FEUTRE NOIR
0021.000		29642 061 1300		FERNBEDIENUNG TP 870	TELECOMMANDE TP 870
0023.000	△	75988 053 3900		BILDROEHRE A51EAL155X17	TUBE IMAGE A51EAL155X17
0024.000	△	75988 053 6200		ENTMAGNETISIERUNGSSPULE 21"	BOBINE DE DEMAGNETISATION 21"
0025.000	△	75988 052 0000	X	LAUFWERK KEIN E-TEIL	PLATINE MECANIQUE VOIR LISTE SEPARÉE
0033.000	3	27599 005 3700		KOPFRAD 4/0 SECAM KPL.	TAMBOUR DE TETES 4/0 SECAM CPL
0050.000	△	27599 101 8400	X	SIGNALCHASSIS KEIN E-TEIL	C.I. TRAITEMENT DU SIGNAL VOIR LISTE SEPARÉE
0070.000	△	27599 103 3100	X	LEISTUNGSSCHASSIS + BILDROHRPL. KEIN E-TEIL	C.I. ALIMENTATION + C.I. TUBE VOIR LISTE SEPARÉE
0080.000	△	27599 002 8300	X	LP-BEDIENMODUL	C.I. COMMANDE
0160.000	3	75988 053 0200	2	TUNER DT5-BF15P	TUNER DT5-BF15P
		72010 537 0000		BEDIENUNGSANLEITUNG F	MODE D'EMPLOI F
		72010 536 6000		SERVICE MANUAL D/GB	INSTRUCTION DE SERVICE D/GB
		72010 536 6100		SERVICE MANUAL ERG. D/GB	INSTRUCTION DE SERVICE D/GB SUPPL.

X = SIEHE GESONDERTE E-LISTE

X = VOIR LISTE DE PIÈCES A PART

Es gelten die Vorschriften und Sicherheitshinweise gemäß dem Service Manual "Sicherheit", Mat.-Nummer 72010 800 0000, sowie zusätzlich die eventuell abweichenden, landesspezifischen Vorschriften!



Il y a lieu d'observer les recommandations et les prescriptions de sécurité de l'Instruction de Service "Sécurité" Réf. N° 72010 800 0000 ainsi que les prescriptions spécifiques à chaque pays!

ÄNDERUNGEN VORBEHALTEN / SOUS RESERVE DE MODIFICATIONS

Ersatzteilliste  
Spare Parts List

10 / 99

POS. NR. POS. NO.	ABB. FIG.	MATERIAL-NR. PART NUMBER	ANZ. QTY.	BEZEICHNUNG (D)	DESCRIPTION (GB)
		77250 123 7200		TVR 5540 FT/GB KEIN E-TEIL	TVR 5540/1 FT/GB NO SPARE PART
0001.000	3	75988 053 5500		GEH.-VORDERTEIL	FRONT PANEL
0002.000	3	75988 053 5700		KLAPPE GEH.-VORDERTEIL	FLAP FRONT PANEL
0003.000	3	75988 053 5800		FEDER KLASPE	SPRING FLAP
0004.000	3	75988 051 0800		VERRIEGELUNG	LOCK
0007.000	3	75988 052 2800		FEDER	SPRING
0008.000	3	75988 053 6400		CASSETTENFACHKLAPPE	LIFT FLAP
0010.000	3	75988 053 6100		FENSTER LED	WINDOW LED
0011.000	3	75988 053 6000		KNOPF EJECT	KNOB EJECT
0013.000	3	75988 053 5900		TASTENSATZ	PUSH BUTTON SET
0014.000		75988 058 6700		ANTENNE	ANTENNA
0015.000	△	75988 053 4600		NETZKABEL	POWER CORD
0016.000	3	75988 053 3300		HALTER NETZKABEL	HOLDER POWER CABLE
0018.000	3	75988 051 1000		LAUTSPRECHER	LOUDSPEAKER
0019.000	3	75988 053 5600		RUECKWAND	REAR CASE
0020.000	3	75988 053 3400	3	FILZ SCHWARZ	FELT BLACK
0021.000		29642 061 1300		FERNBEDIENUNG TP 870	REMOTE CONTROL TP 870
0023.000	△	75988 053 3900		BILDROEHRE A51EAL155X17	TUBE A51EAL155X17
0024.000	△	75988 053 6200		ENTMAGNETISIERUNGSSPULE 21"	DEGAUSING COIL 21"
0025.000	△	75988 052 0000	X	LAUFWERK KEIN E-TEIL	TAPE DRIVE NO SPARE PART
0033.000	3	27599 005 3600		KOPFRAD 4/O PAL KPL	HEAD DISC 4/O PAL ASSY
0050.000	△	27599 101 8700	X	SIGNALCHASSIS KEIN E-TEIL	SIGNALCHASSIS NO SPARE PART
0070.000	△	27599 103 3100	X	LEISTUNGSSCHASSIS + BILDROHRPL. KEIN E-TEIL	POWER CHASSIS + PICT. TUBE BOARD NO SPARE PART
0080.000	△	27599 002 8300	X	LP-BEDIENMODUL	LP-CONTROL BOARD
0160.000	3	75988 053 0200	2	TUNER DT5-BF15P	TUNER DT5-BF15P
		72010 537 1500		BEDIENUNGSANLEITUNG GB	INSTRUCTION MANUAL GB
		72010 536 6000		SERVICE MANUAL D/GB	SERVICE MANUAL D/GB
		72010 536 6100		SERVICE MANUAL ERG. D/GB	SERVICE MANUAL SUPP. D/GB
				X = SIEHE GESONDERTE E-LISTE	X = SEE SEPARATE PARTS LIST

Es gelten die Vorschriften und Sicherheitshinweise gemäß dem Service Manual "Sicherheit", Mat.-Nummer 72010 800 0000, sowie zusätzlich die eventuell abweichenden, landesspezifischen Vorschriften!



The regulations and safety instructions shall be valid as provided by the "Safety" Service Manual, part number 72010 800 0000, as well as the respective national deviations.

ÄNDERUNGEN VORBEHALTEN / SUBJECT TO ALTERATION

GRUNDIG

TVR

TVR 5540 FT/GB

MATERIAL-NR. / PART NO.: 77250 123 7200  
BESTELL-NR. / ORDER NO.: G.CI 36-72 GB

GRUNDIG

TVR

TVR 5540/1 TOP  
TVR 5540/2 TOP \*MATERIAL-NR. / PART NO.: 77250 100 7200 BESTELL-NR. / ORDER NO.: G.CI 33-72  
MATERIAL-NR. / PART NO.: 77250 101 7200 BESTELL-NR. / ORDER NO.: G.CI 34-72 \*Ersatzteilliste  
Spare Parts List

10 / 99

POS. NR. POS. NO.	ABB. FIG.	MATERIAL-NR. PART NUMBER	ANZ. QTY.	BEZEICHNUNG (D)	DESCRIPTION (GB)
		77250 100 7200		TVR 5540/1 TOP KEIN E-TEIL	TVR 5540/1 TOP NO SPARE PART
		77250 101 7200		TVR 5540/2 TOP KEIN E-TEIL	TVR 5540/2 TOP NO SPARE PART
0001.000	3	75988 053 5500		GEH.-VORDERTEIL	FRONT PANEEL
0002.000	3	75988 053 5700		KLAPPE GEH.-VORDERTEIL	FLAP FRONT PANEL
0003.000	3	75988 053 5800		FEDER KLASPE	SPRING FLAP
0004.000	3	75988 051 0800		VERRIEGELUNG	LOCK
0007.000	3	75988 052 2800		FEDER	SPRING
0008.000	3	75988 053 6400		CASSETTENFACHKLAPPE	LIFT FLAP
0010.000	3	75988 053 6100		FENSTER LED	WINDOW LED
0011.000	3	75988 053 6000		KNOPF EJECT	KNOB EJECT
0013.000	3	75988 053 5900		TASTENSATZ	PUSH BUTTON SET
0014.000		75988 058 6700		ANTENNE	ANTENNA
0015.000	△	75988 053 2000		NETZKABEL	POWER CORD
0016.000	3	75988 053 3300		HALTER NETZKABEL	HOLDER POWER CABLE
0018.000	3	75988 051 1000		LAUTSPRECHER	LOUDSPEAKER
0019.000	3	75988 053 5600		RUECKWAND	REAR CASE
0020.000	3	75988 053 3400	3	FILZ SCHWARZ	FELT BLACK
0021.000		29642 061 1300		FERNBEDIENUNG TP 870	REMOTE CONTROL TP 870
0023.000	△	75988 053 3900		BILDROEHRE A51EAL155X17	TUBE A51EAL155X17
0024.000	△	75988 053 6200		ENTMAGNETISIERUNGSSPULE 21"	DEGAUSING COIL 21"
0025.000	△	75988 052 0000	X	LAUFWERK KEIN E-TEIL	TAPE DRIVE NO SPARE PART
0033.000	3	27599 005 3600		KOPFRAD 4/O PAL KPL	HEAD DISC 4/O PAL ASSY
0050.000	△	27599 101 8600	X	SIGNALCHASSIS KEIN E-TEIL	SIGNALCHASSIS NO SPARE PART
0070.000	△	27599 103 3100	X	LEISTUNGSSCHASSIS + BILDROHRPL. KEIN E-TEIL	POWER CHASSIS + PICT. TUBE BOARD NO SPARE PART
0080.000	△	27599 002 8300	X	LP-BEDIENMODUL	LP-CONTROL BOARD
0160.000	3	75988 053 0200	2	TUNER DT5-BF15P	TUNER DT5-BF15P
		72010 536 4600		BEDIENUNGSANLEITUNG D/I	INSTRUCTION MANUAL D/I
		72010 536 4700		BEDIENUNGSANLEITUNG F/NL	INSTRUCTION MANUAL F/NL
		72010 536 4800		BEDIENUNGSANLEITUNG E/P	INSTRUCTION MANUAL E/P
		72010 537 4200	*	BEDIENUNGSANLEITUNG GB	INSTRUCTION MANUAL GB
		72010 537 4000	*	BEDIENUNGSANLEITUNG S/N	INSTRUCTION MANUAL S/N
		72010 537 4100	*	BEDIENUNGSANLEITUNG DK/FIN	INSTRUCTION MANUAL DK/FIN
		72010 536 6000		SERVICE MANUAL D/GB	SERVICE MANUAL D/GB
		72010 536 6100		SERVICE MANUAL ERG. D/GB	SERVICE MANUAL SUPPLEMENT D/GB
				X = SIEHE GESONDERTE E-LISTE	X = SEE SEPARATE PARTS LIST

Es gelten die Vorschriften und Sicherheitshinweise gemäß dem Service Manual "Sicherheit", Mat.-Nummer 72010 800 0000, sowie zusätzlich die eventuell abweichenden, landesspezifischen Vorschriften!



The regulations and safety instructions shall be valid as provided by the "Safety" Service Manual, part number 72010 800 0000, as well as the respective national deviations.

ÄNDERUNGEN VORBEHALTEN / SUBJECT TO ALTERATION

GRUNDIG

TVR

Ersatzteilliste  
Spare Parts List

10 / 99

LAUFWERK  
TAPE DRIVE

MATERIAL-NR. / PART NO.: 75988 052 0000

POS. NR. POS. NO.	ABB. FIG.	MATERIAL-NR. PART NUMBER	ANZ. QTY.	BEZEICHNUNG (D)	DESCRIPTION (GB)
		75988 052 0000		LAUFWERK KEIN E-TEIL	TAPE DRIVE NO SPARE PART
B1910	1	75988 052 1300		FAEDEL MOTOR	LOADING MOTOR
B1940	1	75988 052 1500		SCHALTER FUNKTIONSWAHL	SWITCH FUNCTION SELECTION
B1960	1	75988 052 3100		SCHNECKENRAD	WORMWHEEL
A0300	1	75988 052 3000		SCHIEBER	SLIDER
A0400	1	75988 052 0200		FAEDEL SCHLITTEN S (LINKS)	ROLLER UNIT S (LEFT)
A0500	1	75988 052 0300		FAEDEL SCHLITTEN T (RECHTS)	ROLLER UNIT T (RIGHT)
A0600	2	75988 052 0400		ANTRIEBSRAD LINKS	DRIVE GEAR LEFT
A0700	2	75988 052 0500		ANTRIEBSRAD RECHTS	DRIVE GEAR RIGHT
A0800	2	75988 052 0600		SCHIEBER	SLIDER
A1000	1/2	75988 052 0700		MOTOR CAPSTAN	MOTOR CAPSTAN
A1200	1	75988 052 0800		FEDER	SPRING
A1300	1	75988 052 0900		A/C KOMBIKOPF	A/C HEAD
A1500	1	75988 052 1000		HEBEL	LEVER
A1600	1	75988 052 1100		KURVENRAD	CAM WHEEL
A1700	1	75988 052 1200		ANDRUCKROLLENHEBEL KPL	PRESSURE ROLLER LEVER CPL
A1900	1	75988 052 1400		LEITERPLATTE FAEDEL MOTOR	PCB LOADING MOTOR
AF001	1	75988 052 0100		CASSETTENSCHACHT KPL.	LIFT ASSY
A2100	1	75988 052 1700		RIEMENSCHLEIBE	PULLEY
A2300	1	75988 052 1800		WICKELTELLER	REEL TABLE
A2350	1	75988 052 1800		WICKELTELLER	REEL TABLE
A2500	1	75988 052 1900		BREMZUGHEBEL + BREMSBAND	BRAKE LEVER+BAND
A2600	1	75988 052 2000		FEDER	SPRING
A2700	1	75988 052 2100		2. WICKELTELLERBREMSE LINKS	2ND REEL BRAKE, LEFT
A2800	1	75988 052 2200		1. WICKELTELLERBREMSE RECHTS	1ST REEL BRAKE, RIGHT
A2900	1	75988 052 2300		HAUPTBREMSE	MAIN BRAKE
A3100	1	75988 052 2400		HAUPTLOESCHKOPF	FULL ERASE HEAD
A3300	2	75988 052 2500		RIEMENSCHLEIBE	PULLEY
A3500	2	75988 052 2600		ANTRIEBSRIEMEN	DRIVE BELT
A3600	2	75988 052 2700		HEBEL AUFNAHMESPERRE	LEVER RECORD LOCK
AD001	1	27599 005 3400		KOPFRAD 2/O SP KPL	HEADWHEEL 2/O SP ASSY
AD001	1	27599 005 3500		KOPFRAD 2/O SP/LP KPL	HEADWHEEL 2/O SP/LP ASSY
AD001	1	27599 005 3600		KOPFRAD 4/O PAL KPL	HEADWHEEL 4/O PAL ASSY
AD001	1	27599 005 3700		KOPFRAD 4/O SECAM KPL	HEADWHEEL 4/O SECAM ASSY
				SERVICEMITTEL	ACCESSORIES
		92754 010 1600		TESTCASSETTE (HIFI)	TESTCASSETTE (HIFI)

Es gelten die Vorschriften und Sicherheitshinweise gemäß dem Service Manual "Sicherheit", Mat.-Nummer 72010 800 0000, sowie zusätzlich die eventuell abweichenden, landesspezifischen Vorschriften!



The regulations and safety instructions shall be valid as provided by the "Safety" Service Manual, part number 72010 800 0000, as well as the respective national deviations.

ÄNDERUNGEN VORBEHALTEN / SUBJECT TO ALTERATION

GRUNDIG

TVR

Ersatzteilliste  
Spare Parts List

4 / 2000

ERSETZT AUSGABE 8/99  
SUBSTITUTE EDITION 8/99LEISTUNGSSCHASSIS + BILDROHRPLATTE  
POWER CHASSIS + PICTURE TUBE BOARD

MATERIAL-NR. / PART NO.: 27599 103 3000

POS. NR. POS. NO.	ABB. FIG.	MATERIAL-NR. PART NUMBER	ANZ. QTY.	BEZEICHNUNG (D)	DESCRIPTION (GB)
		27599 103 3000		LEISTUNGSSCHASSIS + BILDROHRPLATTE KEIN E-TEIL	POWER CHASSIS + PICTURE TUBE BOARD NO SPARE PART
C 00410	△	75988 052 3300		ELKO 1MF 160V	I 00801 75988 051 1800 IC STRS5707
C 00416	△	75988 052 3400		KONDENS. 6200PF 1,6KV	I 00802 75988 051 1900 IC K1A7812P1/2
C 00801	△	75988 053 1600		KONDENS. 0.47MF AC250V U/	I 00806 75988 051 2000 IC KIA7806PI
C 00808	△	75988 053 1700		KONDENS. 4700PF 4KV M KX	I 00807 75988 051 2100 IC TOP210
C 00810	△	75988 052 3500		CER 680PF 2KV	I 00808 75988 052 5100 IC KIA78R12
C 00819	△	75988 052 3600		ELKO 180MF 400V	I 00901 83053 361 0600 IC TDA6106Q PHI
C 00823	△	75988 052 3700		ELKO 22MF 400V	I 00902 83053 361 0600 IC TDA6106Q PHI
D 00301		75988 051 1100		DIODE RGP15J	I 00903 83053 361 0600 IC TDA6106Q PHI
D 00302		75988 051 1100		DIODE RGP15J	L 00301 75988 051 2300 SPULE 10UH (LAL04TB)/COIL
D 00401		75988 051 1100		DIODE RGP15J	L 00302 75988 051 2300 SPULE 10UH (LAL04TB)/COIL
D 00402		75988 051 1100		DIODE RGP15J	L 00401 75988 051 2400 SPULE 1UH M/COIL
D 00403		83092 150 4500		DIODE 1N4148	L 00403 75988 052 5800 SPULE AZ-9004Y 940K
D 00405		83092 150 4500		DIODE 1N4148	L 00404 75988 051 2600 SPULE L-125(125UH)/COIL
D 00406		83092 150 4500		DIODE 1N4148	L 00801 △ 75988 051 2700 FILTER LF-24A1
D 00801		75988 051 1200		DIODE 1SS8888	L 00802 75988 051 2800 SPULE HC-3550/COIL
D 00802		75988 051 1200		DIODE 1SS8888	L 00803 75988 051 2800 SPULE HC-3550/COIL
D 00803		75988 051 1200		DIODE 1SS8888	L 00805 75988 051 2800 SPULE HC-3550/COIL
D 00804		75988 051 1200		DIODE 1SS8888	
D 00807		75988 051 1100		DIODE RGP15J	PWC001 △ 75988 053 2000 NETZKABEL/POWER CABLE
D 00808		75988 051 1100		DIODE RGP15J	
D 00809		75988 051 1100		DIODE RGP15J	Q 00301 75988 051 2900 TRANS KTC3198Y
D 00810		75988 051 1100		DIODE RGP15J	Q 00401 75988 051 3000 TRANS KTC3207 (TP)
D 00811		75988 053 1800		DIODE RGP30J	Q 00402 75988 051 3100 TRANS T2SD2499
D 00812	△	75988 053 1800		DIODE RGP30J	Q 00403 75988 053 4700 TRANS KTC 3198Y
D 00813		75988 051 1100		DIODE RGP15J	Q 00803 75988 053 4700 TRANS KTC 3198Y
D 00814		75988 051 1100		DIODE RGP15J	Q 00901 75988 051 3300 TRANS KTA1266Y (TP)
D 00815		75988 053 1100		DIODE RGP15J	
D 00819		75988 051 1300		DIODE RU 1P	R 00419 75988 052 3800 WIDERST. 330HM 1W
D 00822		75987 441 2900		DIODE RU 1 P RU1P	R 00801 75988 052 3900 PTC ECPC 140M 290
D 00823		83092 150 4500		DIODE 1N4148	R 00815 △ 75988 053 1900 WIDERST. 5.6MOHM 0.5W
D 00824		75988 051 1400		DIODE R2-KY	R 00817 △ 75988 051 3400 SICHERHEITSWID. 2W 0.33OH FUSE RESISTOR
D 00825		75988 051 1200		DIODE 1SS8888	
D 00826		75988 051 1200		DIODE 1SS8888	
D 00827		75988 051 1200		DIODE 1SS8888	RLY0001 △ 75988 051 3500 RELAY SW DJ5D2-0(M)-0.25W
D 00828		75988 051 1200		DIODE 1SS8888	RLY0001 △ 75988 051 3600 RELAY SW DG12D1-0(M)-II 1
D 00830		83092 150 1000		DIODE 1 N 4003	
D 00831		75988 052 5000		DIODE DUG2D 200V 2A	SCT 0001 △ 75988 051 3700 SOCKEL BILDROEHRE BASE PICTURE TUBE
D 00901		83092 150 4500		DIODE 1N4148	
D 00902		83092 150 4500		DIODE 1N4148	
D 00903		83092 150 4500		DIODE 1N4148	SG00001 △ 75988 051 3800 FUNKENSTRECKE S-23 900V-1.5KV
D 00904		83092 150 4500		DIODE 1N4148	SG00002 △ 75988 051 3800 FUNKENSTRECKE S-23 900V-1.5KV
F 00801	△	75988 051 1500		SICHERUNG F4AH 4A 250V MF51 FUSE	SG00003 △ 75988 051 3800 FUNKENSTRECKE S-23 900V-1.5KV SPARK GAP
F 00801	△	75988 051 1600		HALTER SICHER. PFC5000-0702	T 00401 △ 75988 051 3900 TRANS HD-15D
F 00801	△	75988 051 1600		HALTER SICHER. PFC5000-0702 HOLDER FUSE	T 00402 △ 75988 053 2100 TRANS FBT FSA36012M
I 00301		75988 051 1700		IC 1TDA8356	T 00801 △ 75988 051 4000 TRANS TSM-40A2A2
					T 00802 △ 75988 051 4100 TRANS ST-22A3

ÄNDERUNGEN VORBEHALTEN / SUBJECT TO ALTERATION

# Ersatzteilliste Spare Parts List

## 8 / 99

ALLE NICHT AUFGEFÜHRTEN E-TEILE  
SIEHE E-LISTE LEISTUNGSSCHASSIS  
27599 103 3000  
ALL PARTS NOT LISTED REFER TO  
PARTS-LIST POWER CHASSIS  
27599 103 3000

## LEISTUNGSSCHASSIS + BILDROHRPLATTE POWER CHASSIS + PICTURE TUBE BOARD

MATERIAL-NR. / PART NO.: 27599 103 3100

POS. NR. ABB. POS. NO. FIG.	MATERIAL-NR. PART NUMBER	ANZ. QTY.	BEZEICHNUNG (D)	DESCRIPTION (GB)
	27599 103 3100		LEISTUNGSSCHASSIS + BILDROHRPLATTE KEIN E-TEIL	POWER CHASSIS + PICTURE TUBE BOARD NO SPARE PART

POS. NR. POS. NO.	MATERIAL-NR. PART NUMBER	BEZEICHNUNG DESCRIPTION	POS. NR. POS. NO.	MATERIAL-NR. PART NUMBER	BEZEICHNUNG DESCRIPTION
L 00404	75988 053 3700	SPULE L-76(76.5UH)/COIL	R 00202	75988 053 2700	TRIMMER EVN D2A A03 10 KOHM
SCT 02	75988 053 4000	SOCKEL BILDROEHRE	R 00580	75988 052 5700	SICHERHEITSWIDERST. 10 OHM 2W
T 00402	75988 053 3800	TRANS HST1142.5057			FUSE RESISTOR
QC 00510	75988 052 2900	TRANS 2SA812-T2B	SF 00001	75988 053 2900	FILTER SAW G 1966M
QC 00511	75988 052 2900	TRANS 2SA812-T2B	SF 00003	75988 053 2900	FILTER SAW G 1966M
QC 00512	75988 052 2900	TRANS 2SA812-T2B	SN 00001	75988 051 9500	IC SENSOR SG-239S
QC 00515	75988 052 2900	TRANS 2SA812-T2B	SN 00002	75988 051 9500	IC SENSOR SG-239S
QC 00601	75988 051 9100	TRANS 2SC1623-L6/T2B	SN 00003	75988 051 9600	FOTOTRANSISTOR ST-5811 (D)
QC 00602	75988 051 9100	TRANS 2SC1623-L6/T2B	SN 00003	75988 053 1500	HALTER FOTOTRANS
QC 00701	75988 051 9100	TRANS 2SC1623-L6/T2B	SN 00004	75988 051 9600	FOTOTRANSISTOR ST-5811 (D)
QC 00703	75988 051 9100	TRANS 2SC1623-L6/T2B	SN 00004	75988 053 1500	HALTER FOTOTRANS
QC 00705	75988 051 9100	TRANS 2SC1623-L6/T2B	SW00001	75988 051 9700	SCHALTER JDS1105-6X
QC 00706	75988 051 9100	TRANS 2SC1623-L6/T2B	SW00002	75988 051 9900	SCHALTER TAKT SKHV10910A SWITCH
QCL0006	75988 051 9100	TRANS 2SC1623-L6/T2B	TY 00001	75988 053 0100	SPULE DEO-006/COIL
QCN0002	75988 051 9100	TRANS 2SC1623-L6/T2B	U 00101	75988 053 0200	TUNER DT5-BF15P
QCN0003	75988 051 9100	TRANS 2SC1623-L6/T2B	U 00101	75988 053 0300	BUCHSE AUDIO MIT KABEL+ST
QCY0001	75988 051 9100	TRANS 2SC1623-L6/T2B	U 00102	75988 053 0200	TUNER DT5-BF15P
QCY0002	75988 052 2900	TRANS 2SA812-T2B	U 00102	75988 053 3000	BUCHSE PHONO MIT KABEL
QCY0003	75988 051 9100	TRANS 2SC1623-L6/T2B	X 00501	75988 053 0400	QUARZ HU-49U 3.579545M
QCY0005	75988 052 2900	TRANS 2SA812-T2B	X 00502	75988 053 0500	QUARZ HC-49U 4.433619M 20
QCY0007	75988 051 9100	TRANS 2SC1623-L6/T2B	X 00701	75988 053 0600	QUARZ HC-49/U 6.0000 MHZ
QCY0008	75988 051 9100	TRANS 2SC1623-L6/T2B	XN 00002	75988 053 0800	QUARZ HC-49S 16.000000MHZ
QCY0009	75988 052 2900	TRANS 2SA812-T2B	XNC0001	75988 053 0900	QUARZ 32.768KHZ 20PPM 803
QCY0010	75988 051 9100	TRANS 2SC1623-L6/T2B	Z 00204	75988 053 1400	FILTER TPS5.5MB-TF21
QCY0011	75988 051 9100	TRANS 2SC1623-L6/T2B	Z 00502	75988 053 1400	FILTER TPS5.5MB-TF21
QCY0012	75988 051 9100	TRANS 2SC1623-L6/T2B			
QCY0013	75988 052 2900	TRANS 2SA812-T2B			
QCY0014	75988 051 9100	TRANS 2SC1623-L6/T2B			
QCY0015	75988 051 9100	TRANS 2SC1623-L6/T2B			
QCY0016	75988 051 9100	TRANS 2SC1623-L6/T2B			
QCY0017	75988 052 2900	TRANS 2SA812-T2B			
QCY0018	75988 051 9100	TRANS 2SC1623-L6/T2B			
QCY0019	75988 051 9100	TRANS 2SC1623-L6/T2B			
QY 00004	75988 053 2600	TRANS KTC3202Y(TP)			
QY 00006	75988 051 2900	TRANS KTC3198Y			

Es gelten die Vorschriften und Sicherheitshinweise gemäß dem Service Manual "Sicherheit", Mat.-Nummer 72010 800 0000, sowie zusätzlich die eventuell abweichenden, landesspezifischen Vorschriften!



The regulations and safety instructions shall be valid as provided by the "Safety" Service Manual, part number 72010 800 0000, as well as the respective national deviations.

ÄNDERUNGEN VORBEHALTEN / SUBJECT TO ALTERATION

POS. NR. POS. NO.	MATERIAL-NR. PART NUMBER	BEZEICHNUNG DESCRIPTION	POS. NR. POS. NO.	MATERIAL-NR. PART NUMBER	BEZEICHNUNG DESCRIPTION
QC 00510	75988 052 2900	TRANS 2SA812-T2B	XN 00002	75988 053 0800	QUARZ HC-49S 16.000000MHZ
QC 00511	75988 052 2900	TRANS 2SA812-T2B	XNC0001	75988 053 0900	QUARZ 32.768KHZ 20PPM 803
QC 00512	75988 052 2900	TRANS 2SA812-T2B	Z 00204	75988 053 1400	FILTER TPS5.5MB-TF21
QC 00515	75988 052 2900	TRANS 2SA812-T2B	Z 00502	75988 053 1400	FILTER TPS5.5MB-TF21
QC 00601	75988 051 9100	TRANS 2SC1623-L6/T2B			
QC 00602	75988 051 9100	TRANS 2SC1623-L6/T2B			
QC 00701	75988 051 9100	TRANS 2SC1623-L6/T2B			
QC 00703	75988 051 9100	TRANS 2SC1623-L6/T2B			
QC 00705	75988 051 9100	TRANS 2SC1623-L6/T2B			
QC 00706	75988 051 9100	TRANS 2SC1623-L6/T2B			
QCL0006	75988 051 9100	TRANS 2SC1623-L6/T2B			
QCN0002	75988 051 9100	TRANS 2SC1623-L6/T2B			
QCN0003	75988 051 9100	TRANS 2SC1623-L6/T2B			
QCY0001	75988 051 9100	TRANS 2SC1623-L6/T2B			
QCY0002	75988 052 2900	TRANS 2SA812-T2B			
QCY0003	75988 051 9100	TRANS 2SC1623-L6/T2B			
QCY0005	75988 052 2900	TRANS 2SA812-T2B			
QCY0007	75988 051 9100	TRANS 2SC1623-L6/T2B			
QCY0008	75988 051 9100	TRANS 2SC1623-L6/T2B			
QCY0009	75988 052 2900	TRANS 2SA812-T2B			
QCY0010	75988 051 9100	TRANS 2SC1623-L6/T2B			
QCY0011	75988 051 9100	TRANS 2SC1623-L6/T2B			
QCY0012	75988 051 9100	TRANS 2SC1623-L6/T2B			
QCY0013	75988 052 2900	TRANS 2SA812-T2B			
QCY0014	75988 051 9100	TRANS 2SC1623-L6/T2B			
QCY0015	75988 051 9100	TRANS 2SC1623-L6/T2B			
QCY0016	75988 051 9100	TRANS 2SC1623-L6/T2B			
QCY0017	75988 052 2900	TRANS 2SA812-T2B			
QCY0018	75988 051 9100	TRANS 2SC1623-L6/T2B			
QCY0019	75988 051 9100	TRANS 2SC1623-L6/T2B			
QY 00004	75988 053 2600	TRANS KTC3202Y(TP)			
QY 00006	75988 051 2900	TRANS KTC3198Y			

Es gelten die Vorschriften und Sicherheitshinweise gemäß dem Service Manual "Sicherheit", Mat.-Nummer 72010 800 0000, sowie zusätzlich die eventuell abweichenden, landesspezifischen Vorschriften!



The regulations and safety instructions shall be valid as provided by the "Safety" Service Manual, part number 72010 800 0000, as well as the respective national deviations.

ÄNDERUNGEN VORBEHALTEN / SUBJECT TO ALTERATION



**GRUNDIG**Ersatzteilliste  
Spare Parts List**TVR****4 / 2000**ERSETZT AUSGABE 9/99  
SUBSTITUTE EDITION 9/99ALLE NICHT AUFGEFÜHRTE E-TEILE  
SIEHE E-LISTE SIGNALCHASSIS 27599 101 8000ALL PARTS NOT LISTED REFER TO  
PARTS-LIST SIGNALCHASSIS 27599 101 8000**SIGNALCHASSIS**

MATERIAL-NR. / PART NO.: 27599 101 8200

POS. NR. POS. NO.	ABB. FIG.	MATERIAL-NR. PART NUMBER	ANZ. QTY.	BEZEICHNUNG (D)	DESCRIPTION (GB)
		27599 101 8200		SIGNALCHASSIS KEIN E-TEIL	SIGNALCHASSIS NO SPARE PART

POS. NR. POS. NO.	MATERIAL-NR. PART NUMBER	BEZEICHNUNG DESCRIPTION	POS. NR. POS. NO.	MATERIAL-NR. PART NUMBER	BEZEICHNUNG DESCRIPTION
D 00101	75988 051 5500	DIODE 1SS85TA	Q 00702	75988 053 4700	TRANS KTC3198Y
D 00102	75988 051 5500	DIODE 1SS85TA	QC 00201	75988 053 4800	TRANS KTC3881
D 00103	83092 150 4500	DIODE 1N4148	QC 00202	75988 051 9100	TRANS 2SA812-T2B
D 00104	83092 150 4500	DIODE 1N4148	QC 00203	75988 051 9100	TRANS 2SA812-T2B
D 00108	75988 053 4100	DIODE BB909A	QC 00204	75988 051 9100	TRANS 2SA812-T2B
D 00109	75988 051 5200	Z-DIODE UZ-5.1BM	QC 00704	75988 051 9100	TRANS 2SA812-T2B
D 00110	75988 051 5200	Z-DIODE UZ-5.1BM	QCL 0001	75988 053 4800	TRANS KTC3881
DL 00001	75988 051 5500	DIODE 1SS85TA	QCL 0002	75988 051 9100	TRANS 2SA812-T2B
DL 00002	75988 051 5500	DIODE 1SS85TA	QCL 0003	75988 051 9100	TRANS 2SA812-T2B
DY 00001	83092 150 4500	DIODE 1N4148	QCL 0005	75988 051 9100	TRANS 2SA812-T2B
I 00201	75988 053 4200	IC TDA 9802	QCL 0007	75988 051 9100	TRANS 2SA812-T2B
I 00501	75988 052 4700	IC TDA8842/N2	R 00240	75988 053 4900	ESTR ENV-DJAA03B14 10KOHM
IL 00001	75988 053 4300	IC STV 8225	SF 00001	75988 053 5000	FILTER 5PJ1952M
IL 00002	75988 053 4300	IC STV 8225	SF 00002	75988 053 5100	FILTER 5PL9453M
IY 00003	75988 053 4400	IC TA 1238N	SF 00003	75988 053 5000	FILTER 5PJ1952M
			SF 00004	75988 053 5100	FILTER 5PL9453M
L 00202	75988 053 4500	SPULE 6.8 UH K (AXIAL 3.5/COIL)	Z 00204	75988 053 1200	FILTER SFSH5.5MCB-TF21
LL 00003	75988 051 8400	SPULE 100UH/COIL	Z 00206	75988 053 1400	FILTER TPS5.5MB-TF21
LY 00003	75988 051 8400	SPULE 100UH/COIL	Z 00502	75988 053 1200	FILTER SFSH5.5MCB-TF21
			Z 00504	75988 053 1400	FILTER TPS5.5MB-TF21

Es gelten die Vorschriften und Sicherheitshinweise gemäß dem Service Manual "Sicherheit", Mat.-Nummer 72010 800 0000, sowie zusätzlich die eventuell abweichenden, landesspezifischen Vorschriften!



The regulations and safety instructions shall be valid as provided by the "Safety" Service Manual, part number 72010 800 0000, as well as the respective national deviations.

ÄNDERUNGEN VORBEHALTEN / SUBJECT TO ALTERATION

**GRUNDIG**Ersatzteilliste  
Spare Parts List**TVR****9 / 99**ALLE NICHT AUFGEFÜHRTE E-TEILE  
SIEHE E-LISTE SIGNALCHASSIS 27599 101 8000ALL PARTS NOT LISTED REFER TO  
PARTS-LIST SIGNALCHASSIS 27599 101 8000**SIGNALCHASSIS**

MATERIAL-NR. / PART NO.: 27599 101 8300

POS. NR. POS. NO.	ABB. FIG.	MATERIAL-NR. PART NUMBER	ANZ. QTY.	BEZEICHNUNG (D)	DESCRIPTION (GB)
		27599 101 8300		SIGNALCHASSIS KEIN E-TEIL	SIGNALCHASSIS NO SPARE PART

POS. NR. POS. NO.	MATERIAL-NR. PART NUMBER	BEZEICHNUNG DESCRIPTION	POS. NR. POS. NO.	MATERIAL-NR. PART NUMBER	BEZEICHNUNG DESCRIPTION
IY 00004	75988 051 7000	IC LA 70001	Z 00204	75988 053 5300	FILTER SFSH6.0MCB-TF21
L 00202	75988 051 8100	SPULE 15UH/COIL	Z 00206	75988 053 5400	FILTER TPS 6.0MB(EFC-S6ROME3)
SF 00001	75988 053 5000	FILTER J1952M	Z 00502	75988 053 5200	QUARZ HC-49S 4.286000M
SF 00003	75988 053 5000	FILTER J1952M	Z 00504	75988 053 5400	FILTER TPS 6.0MB(EFC-S6ROME3)

Es gelten die Vorschriften und Sicherheitshinweise gemäß dem Service Manual "Sicherheit", Mat.-Nummer 72010 800 0000, sowie zusätzlich die eventuell abweichenden, landesspezifischen Vorschriften!



The regulations and safety instructions shall be valid as provided by the "Safety" Service Manual, part number 72010 800 0000, as well as the respective national deviations.

ÄNDERUNGEN VORBEHALTEN / SUBJECT TO ALTERATION

GRUNDIG

Ersatzteilliste  
Pièces détachées

TVR

4 / 2000

ERSETZT AUSGABE 9/99  
REMPLACE L'EDITION 9/99ALLE NICHT AUFGEFÜHRTEN E-TEILE  
SIEHE E-LISTE SIGNALCHASSIS 27599 101 8000POUR LES PIECES DETACHEES NON  
MENTIONNEES VOIR ETAGE DE TRAITEMENT  
DU SIGNAL 27599 101 8000SIGNALCHASSIS  
ETAGE DE TRAITEMENT  
DU SIGNALMATERIAL-NR. / N<sup>o</sup> REFERENCE.: 27599 101 8400

POS. NR. N <sup>o</sup> POS.	ABB. FIG.	MATERIAL-NR. REFERENCE	ANZ. NB	BEZEICHNUNG DESIGNATION
		27599 101 8400		SIGNALCHASSIS KEIN E-TEIL
				ETAGE DE TRAITEMENT DU SIGNAL VOIR LISTE SEPARÉE

POS. NR. N <sup>o</sup> POS.	MATERIAL-NR. REFERENCE	BEZEICHNUNG DESIGNATION	POS. NR. N <sup>o</sup> POS.	MATERIAL-NR. REFERENCE	BEZEICHNUNG DESIGNATION
D 00101	75988 051 5500	DIODE 1SS85TA	QCL 00007	75988 051 9100	TRANS 2SC1623-L6/T2B
D 00102	75988 051 5500	DIODE 1SS85TA	SCT 00002	75988 053 4000	SOCKET BILDROEHRE ISHS-09
D 00104	83092 150 4500	DIODE 1N4148	SF 00001	75988 053 5000	FILTER 5PJ1952M
D 00108	75988 053 4100	DIODE BB909A	SF 00002	75988 053 5100	FILTER 5PL9453M
D 00109	75988 051 5200	Z-DIODE UZ-5.1BM	SF 00003	75988 053 5000	FILTER 5PJ1952M
D 00110	75988 051 5200	Z-DIODE UZ-5.1BM	SF 00004	75988 053 5100	FILTER 5PL9453M
DL 00001	75988 051 5500	DIODE 1SS85TA	T 00402	75988 053 3800	TRANS HST1142.5057
DL 00002	75988 051 5500	DIODE 1SS85TA			
DN 00007	83092 150 4500	DIODE 1N4148			
I 00201	75988 053 4200	IC TDA 9802			
I 00501	75988 052 4700	IC TDA 8842/N2			
IL 00001	75988 053 4300	IC STV 8225			
IL 00002	75988 053 4300	IC STV 8225			
IY 00003	75988 053 4400	IC TA 1238N			
IY 00004	75988 053 3600	IC LA70011			
L 00202	75988 053 4500	SPULE 6.8 UH K			
L 00404	75988 053 3700	SPULE L-76(76.5UH)			
LL 00003	75988 051 8400	SPULE 100UH			
LY 00002	75988 051 8400	SPULE 100UH			
M 00191	75988 053 6300	SENSOR DEKO			
M 00591	75988 053 6600	LED DEKO			
Q 00702	75988 053 4700	TRANS KTC3198Y			
QC 00201	75988 053 4800	TRANS KTC3881			
QC 00202	75988 051 9100	TRANS 2SC1623-L6/T2B			
QC 00203	75988 051 9100	TRANS 2SC1623-L6/T2B			
QC 00204	75988 051 9100	TRANS 2SC1623-L6/T2B			
QC 00704	75988 051 9100	TRANS 2SC1623-L6/T2B			
QCL 00001	75988 053 4800	TRANS KTC3881			
QCL 00002	75988 051 9100	TRANS 2SC1623-L6/T2B			
QCL 00003	75988 051 9100	TRANS 2SC1623-L6/T2B			
QCL 00005	75988 051 9100	TRANS 2SC1623-L6/T2B			
QCL 00007	75988 051 9100	TRANS 2SC1623-L6/T2B			

Es gelten die Vorschriften und Sicherheitshinweise gemäß dem Service Manual "Sicherheit", Mat.-Nummer 72010 800 0000, sowie zusätzlich die eventuell abweichenden, landesspezifischen Vorschriften!



Il y a lieu d'observer les recommandations et les prescriptions de sécurité de l'Instruction de Service "Sécurité" Réf. N<sup>o</sup> 72010 800 0000 ainsi que les prescriptions spécifiques à chaque pays!

ÄNDERUNGEN VORBEHALTEN / SOUS RESERVE DE MODIFICATIONS

GRUNDIG

Ersatzteilliste  
Pièces détachées

TVR

4 / 2000

ERSETZT AUSGABE 9/99  
REMPLACE L'EDITION 9/99ALLE NICHT AUFGEFÜHRTEN E-TEILE  
SIEHE E-LISTE SIGNALCHASSIS 27599 101 8000POUR LES PIECES DETACHEES NON  
MENTIONNEES VOIR ETAGE DE TRAITEMENT  
DU SIGNAL 27599 101 8000SIGNALCHASSIS  
ETAGE DE TRAITEMENT  
DU SIGNALMATERIAL-NR. / N<sup>o</sup> REFERENCE.: 27599 101 8500

POS. NR. N <sup>o</sup> POS.	ABB. FIG.	MATERIAL-NR. REFERENCE	ANZ. NB	BEZEICHNUNG DESIGNATION
		27599 101 8500		SIGNALCHASSIS KEIN E-TEIL
				ETAGE DE TRAITEMENT DU SIGNAL VOIR LISTE SEPARÉE

POS. NR. N <sup>o</sup> POS.	MATERIAL-NR. REFERENCE	BEZEICHNUNG DESIGNATION	POS. NR. N <sup>o</sup> POS.	MATERIAL-NR. REFERENCE	BEZEICHNUNG DESIGNATION
D 00104	83092 150 4500	DIODE 1N4148			
D 00113	75988 051 5200	Z-DIODE UZ-5.1BM			
DL 00001	75988 051 5500	DIODE 1SS85TA			
DL 00002	75988 051 5500	DIODE 1SS85TA			
I 00501	75988 052 4700	IC TDA 8842/N2			
IL 00001	75988 053 4300	IC STV 8225			
IY 00003	75988 053 4400	IC TA 1238N			
LL 00003	75988 051 8400	SPULE 100UH			
LY 00002	75988 051 8400	SPULE 100UH			
Q 00702	75988 053 4700	TRANS KTC3198Y			
QCL 00001	75988 053 4800	TRANS KTC3881			
QCL 00002	75988 051 9100	TRANS 2SC1623-L6/T2B			
QCL 00003	75988 051 9100	TRANS 2SC1623-L6/T2B			
QCL 00005	75988 051 9100	TRANS 2SC1623-L6/T2B			
QCL 00007	75988 051 9100	TRANS 2SC1623-L6/T2B			
R 00202	75988 053 2700	TRIMMER EVN D2A A03 10 KOHM			
SF 00001	75988 053 5000	FILTER 5PJ1952M			
SF 00002	75988 053 5100	FILTER 5PL9453M			

Es gelten die Vorschriften und Sicherheitshinweise gemäß dem Service Manual "Sicherheit", Mat.-Nummer 72010 800 0000, sowie zusätzlich die eventuell abweichenden, landesspezifischen Vorschriften!



Il y a lieu d'observer les recommandations et les prescriptions de sécurité de l'Instruction de Service "Sécurité" Réf. N<sup>o</sup> 72010 800 0000 ainsi que les prescriptions spécifiques à chaque pays!

ÄNDERUNGEN VORBEHALTEN / SOUS RESERVE DE MODIFICATIONS

Ersatzteilliste  
Spare Parts List

9 / 99

ALLE NICHT AUFGEFÜHRTEN E-TEILE  
SIEHE E-LISTE SIGNALCHASSIS 27599 101 8000ALL PARTS NOT LISTED REFER TO  
PARTS-LIST SIGNALCHASSIS 27599 101 8000TVR  
SIGNALCHASSIS

MATERIAL-NR. / PART NO.: 27599 101 8600

POS. NR. POS. NO.	ABB. FIG.	MATERIAL-NR. PART NUMBER	ANZ. QTY.	BEZEICHNUNG D	DESCRIPTION GB
		27599 101 8600		SIGNALCHASSIS KEIN E-TEIL	SIGNALCHASSIS NO SPARE PART

POS. NR. POS. NO.	MATERIAL-NR. PART NUMBER	BEZEICHNUNG DESCRIPTION	POS. NR. POS. NO.	MATERIAL-NR. PART NUMBER	BEZEICHNUNG DESCRIPTION
DN 00007	83092 150 4500	DIODE 1N4148	L 00404	75988 053 3700	SPULE L-76(76.5UH)/COIL
IY 00004	75988 053 3600	IC LA70011	M 00191	75988 053 6300	SENSOR DEKO

Ersatzteilliste  
Spare Parts List

9 / 99

ALLE NICHT AUFGEFÜHRTEN E-TEILE  
SIEHE E-LISTE SIGNALCHASSIS 27599 101 8000ALL PARTS NOT LISTED REFER TO  
PARTS-LIST SIGNALCHASSIS 27599 101 8000TVR  
SIGNALCHASSIS

MATERIAL-NR. / PART NO.: 27599 101 8700

POS. NR. POS. NO.	ABB. FIG.	MATERIAL-NR. PART NUMBER	ANZ. QTY.	BEZEICHNUNG D	DESCRIPTION GB
		27599 101 8700		SIGNALCHASSIS KEIN E-TEIL	SIGNALCHASSIS NO SPARE PART

POS. NR. POS. NO.	MATERIAL-NR. PART NUMBER	BEZEICHNUNG DESCRIPTION	POS. NR. POS. NO.	MATERIAL-NR. PART NUMBER	BEZEICHNUNG DESCRIPTION
DN 00007	83092 150 4500	DIODE 1N4148	SCT002	75988 053 4000	SOCKEL BILDROEHRE ISHS-09
I 00506	75988 053 6900	IC TC4066BP	SF 00001	75988 053 5000	FILTER SAW J1952M
IY 00004	75988 053 3600	IC LA70011	SF 00003	75988 053 5000	FILTER SAW J1952M
L 00404	75988 053 3700	SPULE L-76(76.5UH)/COIL	T 00402	75988 053 3800	TRAF0 HST1142.5057
M 00191	75988 053 6300	SENSOR	Z 00204	75988 053 5300	FILTER SFSH6.0MCB-TF21
QC 00515	75988 053 7000	TRANS 2SA812-T2B	Z 00206	75988 053 5400	FILTER TPS 6.0MB
			Z 00502	75988 053 5300	FILTER SFSH6.0MCB-TF21
			Z 00504	75988 053 5400	FILTER TPS 6.0MB

Es gelten die Vorschriften und Sicherheitshinweise gemäß dem Service Manual "Sicherheit", Mat.-Nummer 72010 800 0000, sowie zusätzlich die eventuell abweichenden, landesspezifischen Vorschriften!



The regulations and safety instructions shall be valid as provided by the "Safety" Service Manual, part number 72010 800 0000, as well as the respective national deviations.

ÄNDERUNGEN VORBEHALTEN / SUBJECT TO ALTERATION

Ersatzteilliste  
Spare Parts List

4 / 2000

ERSETZT AUSGABE 9/99  
SUBSTITUTE EDITION 9/99TVR  
LP-BEDIENMODUL  
LP CONTROL BOARD

MATERIAL-NR. / PART NO.: 27599 002 8300

POS. NR. POS. NO.	ABB. FIG.	MATERIAL-NR. PART NUMBER	ANZ. QTY.	BEZEICHNUNG D	DESCRIPTION GB
		27599 002 8300		LP-BEDIENMODUL	LP-CONTROL BOARD

POS. NR. POS. NO.	MATERIAL-NR. PART NUMBER	BEZEICHNUNG DESCRIPTION	POS. NR. POS. NO.	MATERIAL-NR. PART NUMBER	BEZEICHNUNG DESCRIPTION
----------------------	-----------------------------	----------------------------	----------------------	-----------------------------	----------------------------

DF 00001	75988 051 4200	LED SLR 34VC-3 (ROT)			
DF 00002	75988 051 4200	LED SLR 34VC-3 (ROT)			
DF 00003	75988 051 4200	LED SLR 34VC-3 (ROT)			
DF 00004	75981 252 0000	DIODE UZ 6,2 B UZ 6,2 B			
DF 00005	75981 252 0000	DIODE UZ 6,2 B UZ 6,2 B			
DF 00006	83092 150 4500	DIODE 1N4148			
DF 00007	83092 150 4500	DIODE 1N4148			
DF 00008	75988 252 0000	Z-DIODE UZ-6.2BM 6.2V			
DF 00011	83092 150 4500	DIODE 1N4148			
IF 00001	75988 052 5300	IC TSOP 1238			
JF 00001	75988 051 4300	BUCHSE PHONO LGT1516-0100 SOCKET			
LF 00001	75988 051 4500	SPULE 10UH (LAL04TB)/COIL			
QF 00001	75988 051 4700	TRANS KTC3198Y			
QF 00002	75988 051 4700	TRANS KTC3198Y			
QF 00003	75988 051 4700	TRANS KTC3198Y			
QF 00004	75988 051 4700	TRANS KTC3198Y			
SW00003	75988 051 4800	SCHALTER TAKT SKHV10910A			
SW00004	75988 051 4800	SCHALTER TAKT SKHV10910A			
SW00005	75988 051 4800	SCHALTER TAKT SKHV10910A			
SW00006	75988 051 4800	SCHALTER TAKT SKHV10910A			
SW00007	75988 051 4800	SCHALTER TAKT SKHV10910A			
SW00008	75988 051 4800	SCHALTER TAKT SKHV10910A			
SW00009	75988 051 4800	SCHALTER TAKT SKHV10910A			
SW00010	75988 051 4800	SCHALTER TAKT SKHV10910A			
SW00011	75988 051 4800	SCHALTER TAKT SKHV10910A			
SW00012	75988 051 4800	SCHALTER TAKT SKHV10910A PUSHBUTTON SWITCH (NON-LOCKING)			
SW00013	75988 053 2200	SCHALTER DRUCK SPPH 2C 2P PUSHBUTTON SWITCH (LOCKING)			

Es gelten die Vorschriften und Sicherheitshinweise gemäß dem Service Manual "Sicherheit", Mat.-Nummer 72010 800 0000, sowie zusätzlich die eventuell abweichenden, landesspezifischen Vorschriften!



The regulations and safety instructions shall be valid as provided by the "Safety" Service Manual, part number 72010 800 0000, as well as the respective national deviations.

ÄNDERUNGEN VORBEHALTEN / SUBJECT TO ALTERATION